

DIAGNOMATIC

www.diagnostic.com

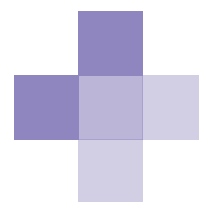

Radiography / Fluoroscopy



ISO
9001

ISO
13485

ISO
14001

ISO
45001

ISO
27001



Radiography / Fluoroscopy

Quality Control kits

Powered by:



We have prepared several QA / QC kits consisting of must-have phantoms, accessories and software that you can use in different situations depending on your requirements.

These can be your go-to selections when you are not sure what to choose for tests of a given modality.

We have introduced gradation of kits depending on the purpose and level of sophistication required:

BASIC: these sets are meant for constancy level testing purposes - tests that can be done practically by everyone who can use a diagnostic device

PRO: sets meant for acceptance and specialized testing - performed by specialized personnel, for example a medical physicist



Pro-Digi BASIC kit

02-001

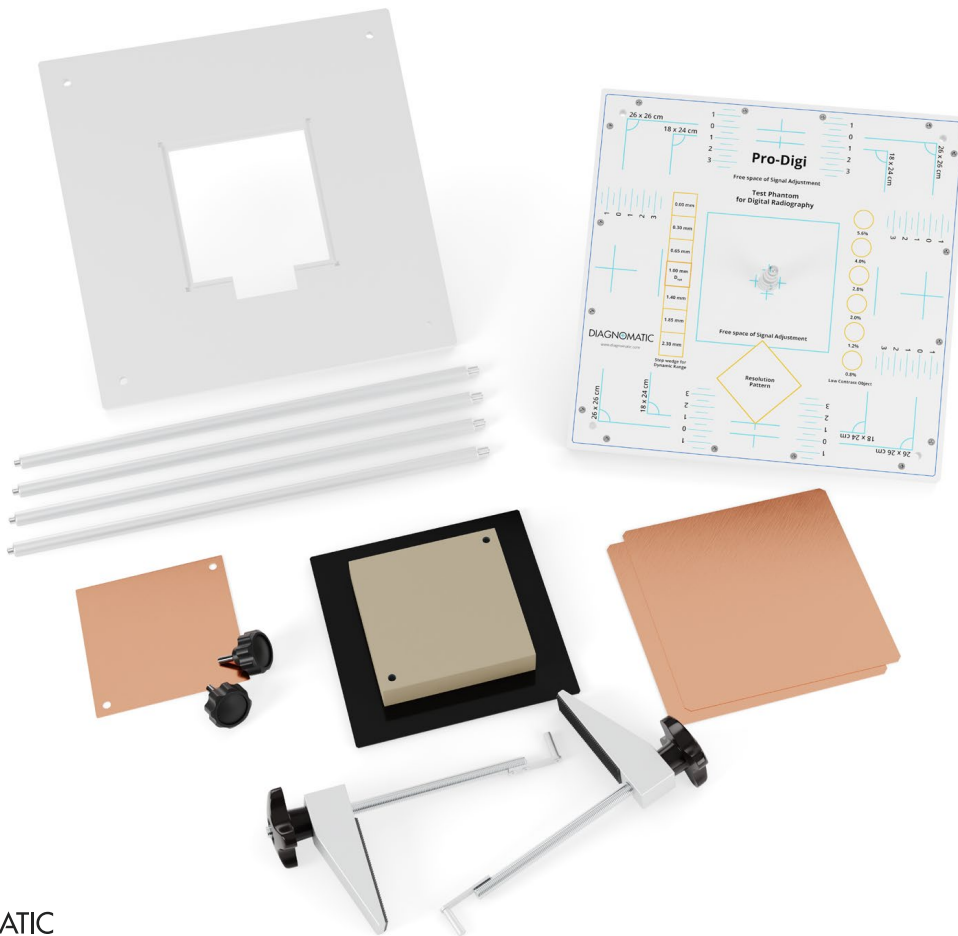

Powered by:



This kit is a versatile set of phantoms and software for carrying out constancy tests of radiography x-ray units. Thanks to the Diagnostics subscription, all tests can be quickly and effortlessly automatically analysed online.

Standard kit configuration:

- Pro-Digi (02-102)
- Pro-RF Al25 (02-303)
- Pro-RF Cu 1 (02-304)
- Pro-RF Rack (02-301)
- Pro-RF Stand (02-302)
- Pro-RF AEC Cu (02-203)
- Diagnostics BASIC annual subscription
- carrying case with dedicated foam inlay

The kit can be used to measure:

- collimation / beam alignment
- position and size of the effective radiation field
- dynamic range
- spatial resolution
- contrast resolution
- homogeneity
- AEC tests
- dose reproducibility

Product features:

- complies with:
 - IEC 61223-3-1
 - DIN 6868/58 and DIN 6868/13
- CE certified
- the Manual provides detailed guidelines for carrying out each test, results assessment and registration



Pro-RF BASIC kit

02-011

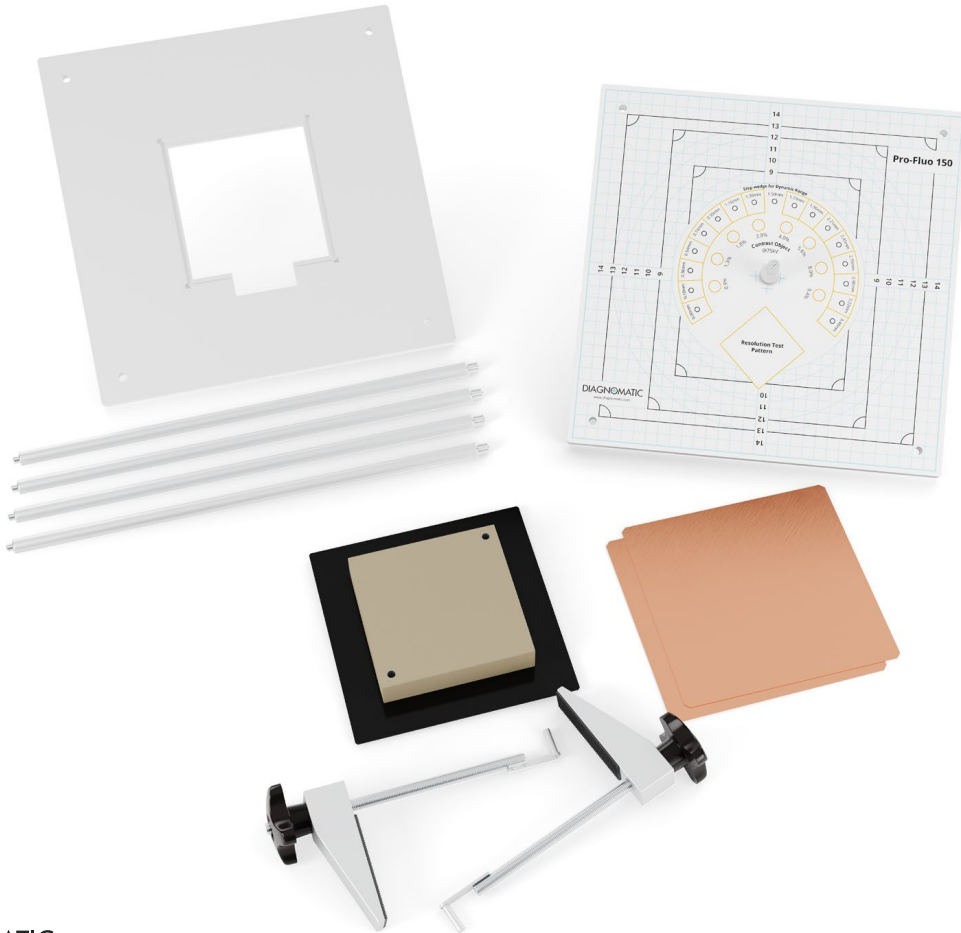

Powered by:



This kit is a versatile set of phantoms and software for carrying out constancy tests of radiography and fluoroscopy units. Thanks to the Diagnostics subscription, all tests can be quickly and effortlessly automatically analysed online.

Standard kit configuration:

- Pro-Fluo 150
- Pro-RF AI 25
- Pro-RF Rack
- Pro-RF Stand
- Pro-RF AEC Cu
- Diagnostics BASIC annual subscription
- carrying case with dedicated foam inlay

The kit can be used to measure:

- collimation/beam alignment
- position and size of the effective radiation field
- dynamic range
- spatial resolution
- contrast resolution
- homogeneity
- beam quality
- image distortion
- AEC tests
- dose reproducibility

Product features:

- complies with:
 - IEC 61223-3-1
 - DIN 6868-150
- CE certified
- the Manual provides detailed guidelines for carrying out each test, results assessment and registration

Pro-Digi PRO kit



02-002

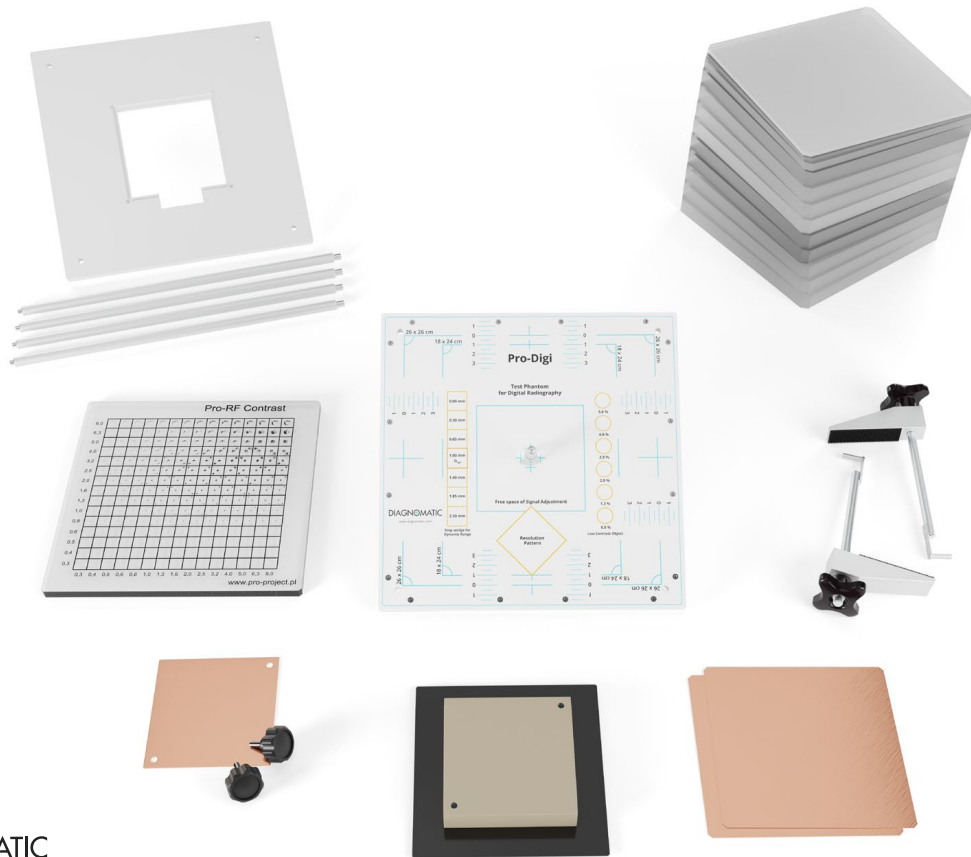

Powered by:



This kit is a versatile set of phantoms and software for carrying out constancy and acceptance tests of radiography x-ray units. Thanks to the Diagnostics subscription, all tests can be quickly and effortlessly automatically analysed online.

Standard kit configuration:

- Pro-Digi (02-102)
- Pro-RF Al25 (02-303)
- Pro-RF Cu 1 (02-304)
- Pro-RF Rack (02-301)
- Pro-RF Stand (02-302)
- Pro-RF AEC Cu (02-203)
- Pro-RF AEC PMMA (02-221)
- Pro-RF Contrast (02-109)
- Diagnostics PRO annual subscription
- carrying case with dedicated foam inlay

The kit can be used to measure:

- collimation / beam alignment
- position and size of the effective radiation field
- dynamic range
- spatial resolution
- contrast resolution
- homogeneity
- AEC tests
- dose reproducibility

Product features:

- complies with:
 - IEC 61223-3-1
 - DIN 6868/58 and DIN 6868/13
- CE certified
- the Manual provides detailed guidelines for carrying out each test, results assessment and registration

Pro-RF PRO kit



02-012

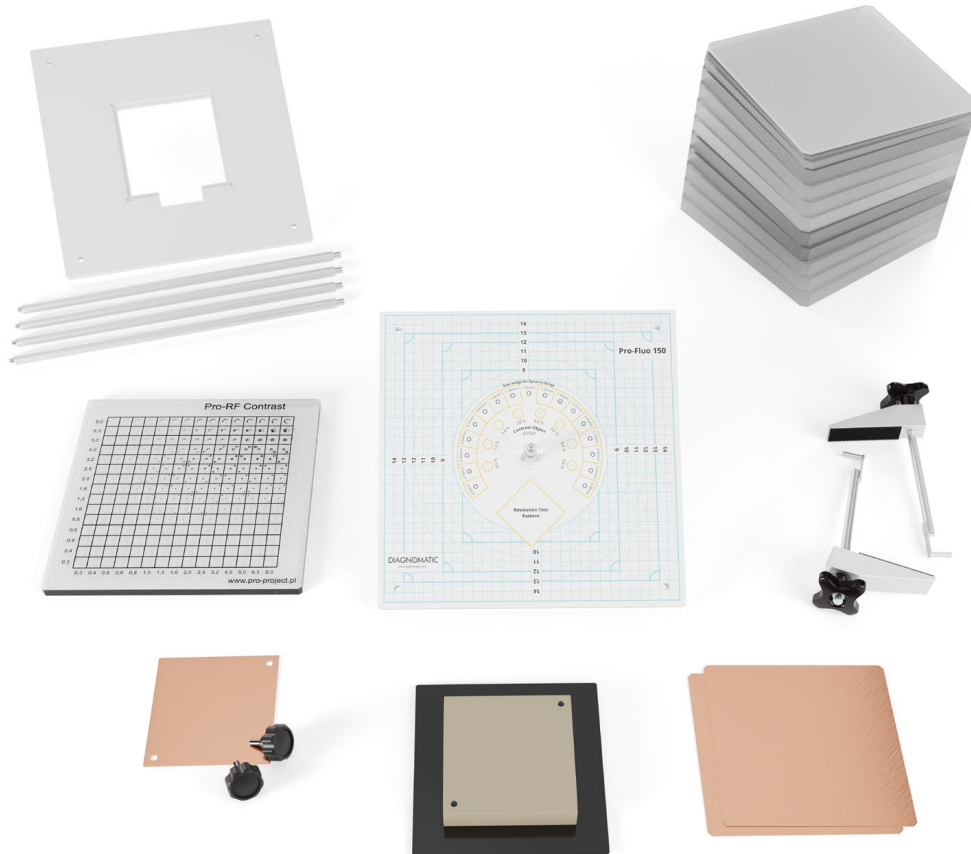

Powered by:



This kit is a versatile set of phantoms and software for carrying out constancy tests of radiography and fluoroscopy units. Thanks to the Diagnostics subscription, all tests can be quickly and effortlessly automatically analysed online.

Standard kit configuration:

- Pro-Fluo 150
- Pro-RF AI 25
- Pro-RF Rack
- Pro-RF Stand
- Pro-RF AEC Cu
- Pro-RF AEC PMMA (02-221)
- Pro-RF Contrast (02-109)
- Diagnostics PRO annual subscription
- carrying case with dedicated foam inlay

The kit can be used to measure:

- collimation / beam alignment
- position and size of the effective radiation field
- dynamic range
- spatial resolution
- contrast resolution
- homogeneity
- AEC tests
- CNR, SNR
- contrast details
- dose reproducibility
- focal spot size

Product features:

- complies with:
 - IEC 61223-3-1
 - DIN 6868-150
- CE certified
- the Manual provides detailed guidelines for carrying out each test, results assessment and registration



Radiography / Fluoroscopy

Phantoms

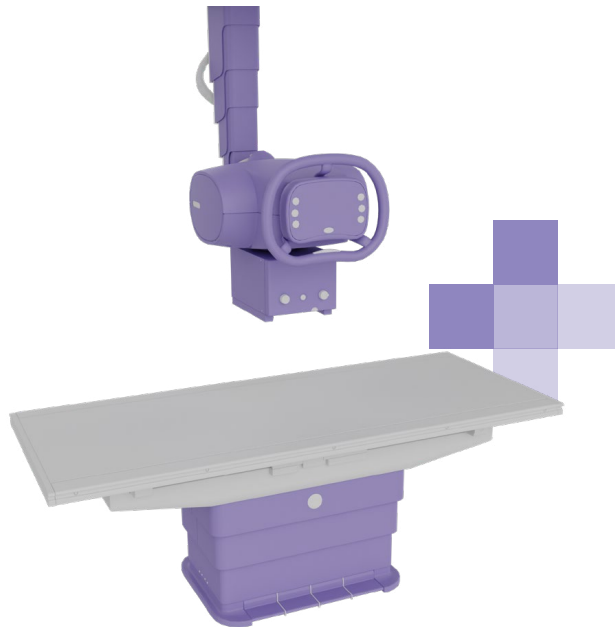

Pro-Alpha



02-101

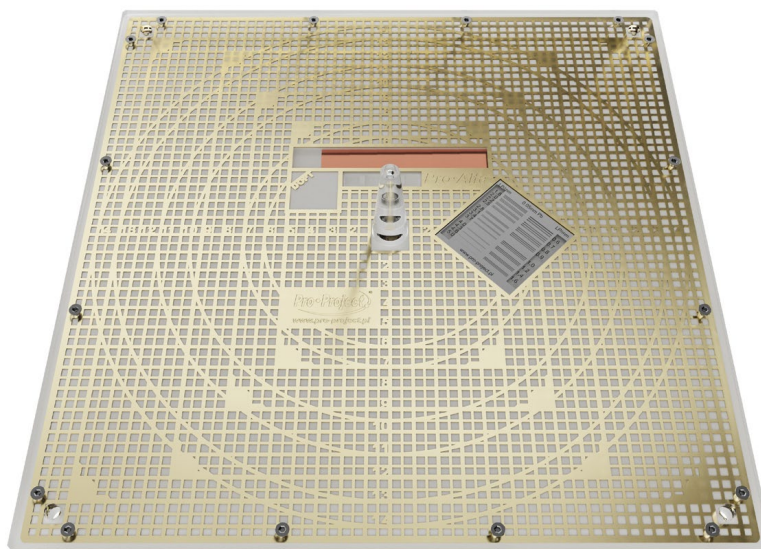

The Pro-Alpha phantom can be used for carrying out **acceptance and constancy tests of conventional radiography X-Ray units**.

With the Pro-Alpha phantom, you can do the following tests:

- collimation / beam alignment
- position and size of the effective radiation field
- dynamic range
- spatial resolution
- contrast resolution
- image quality (distortion in fluoroscopy)

Technical data (can be modified to customer specifications):

- dimensions: 300 x 300 x 10 mm
- brass mesh pattern (5 mm scale) embedded in PMMA
- 7-step copper wedge
- 4 low contrast elements
- markings to determine the size and position of the effective radiation field
- pattern for line pair resolution evaluation (from 0.6 to 5.0 LP/mm)
- cone for the perpendicular X-Ray beam control in the range of $0^\circ \div 1.5^\circ$

Product features:

- complies with:
 - IEC 61223-3-1
 - DIN 6868/3 and DIN 6868/4
- CE certified
- the Manual provides detailed guidelines for carrying out each test, results assessment and registration

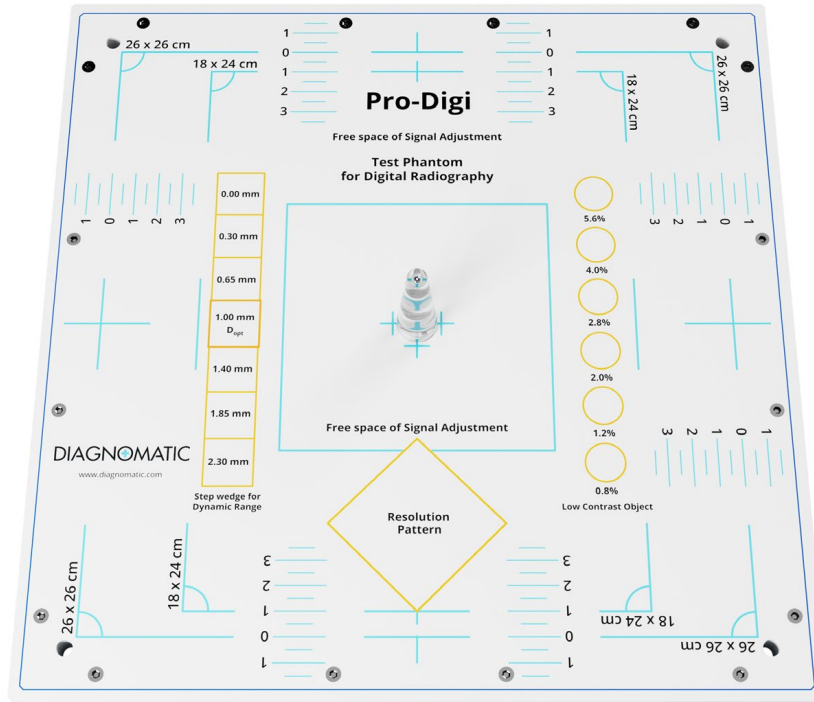

The Pro-Digi phantom is dedicated for **acceptance and constancy tests of digital radiography** equipment.

It can be used to measure:

- collimation / beam alignment
- position and size of the effective radiation field
- dynamic range
- spatial resolution
- contrast resolution
- homogeneity

Technical data (can be modified to customer specifications):

- dimensions: 310 x 310 x 14 mm
- 1mm thick copper plate embedded in PMMA
- 7-step copper wedge
- 6 low contrast elements
- free area for signal calibration
- markings to determine the size and position of the effective radiation field
- pattern for line pair resolution evaluation (from 0.6 to 5.0 LP/mm)
- cone for perpendicular X-Ray beam control in the range of $0^\circ \div 1.5^\circ$

Product features:

- complies with:
 - IEC 61223-3-1
 - DIN 6868/58 and DIN 6868/13
- CE certified
- the Manual provides detailed guidelines for carrying out each test, results assessment and registration

Pro-Fluo 150



02-115

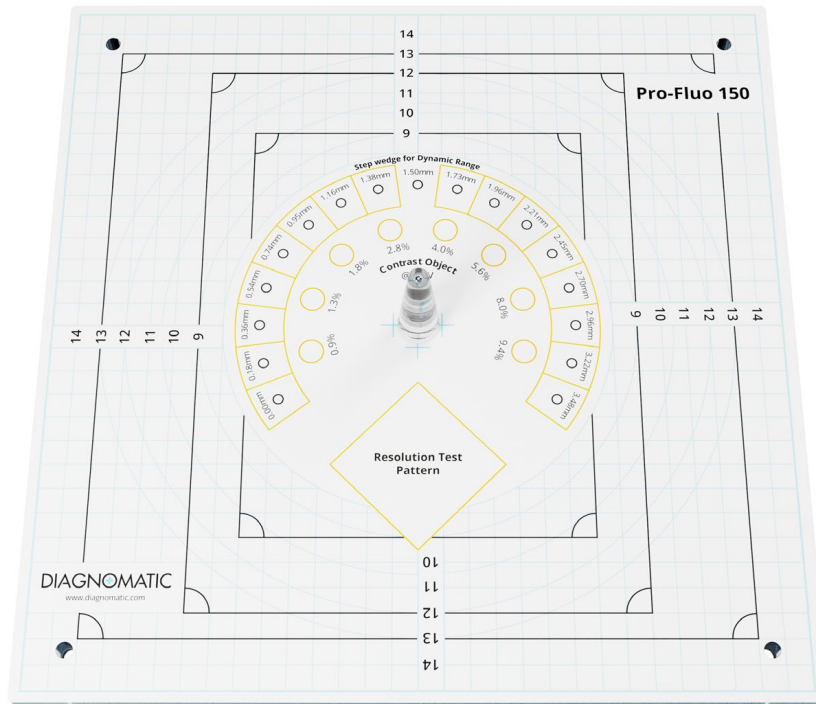

The **Pro-Fluo 150 phantom** is dedicated for acceptance and constancy tests of radiography and fluoroscopy equipment **according to the new DIN 6868-150 standard**.

It can be used to measure:

- collimation / beam alignment
- position and size of the effective radiation field
- dynamic range
- spatial resolution
- contrast resolution
- homogeneity
- beam quality

Technical data (can be modified to customer specifications):

- dimensions: 310 x 310 x 18,5 mm
- 1.5 mm thick copper plate with mesh pattern embedded in PMMA
- total PMMA thickness 17 mm
- 17-step copper wedge (thickness 0.0 mm to 3.48 mm) with additional low contrast details (4 mm diameter)
- 8 low contrast elements (10 mm diameter)
- pattern for line pair resolution evaluation (from 0.6 to 5.0 LP/mm)
- markings to determine the size and position of the effective radiation field
- cone for perpendicular X-Ray beam control in the range of $0^\circ \div 1.5^\circ$

Product features:

- complies with:
 - IEC 61223-3-1
 - DIN 6868-150
- CE certified
- the Manual provides detailed guidelines for carrying out each test, results assessment and registration

Pro-RF Rack



02-301

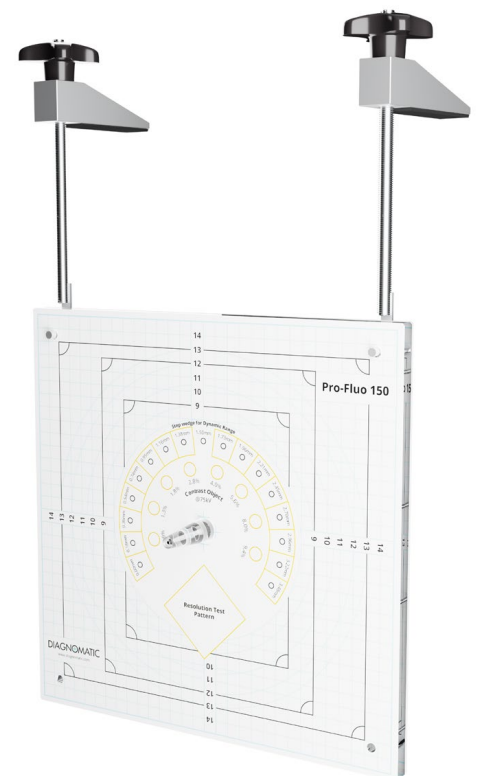

A phantom holder for Pro-Alpha, Pro-Digi and Pro-Fluo test phantoms **for mounting on Bucky grid wall stands**. It allows precise and safe positioning.

Technical data (can be modified to customer specifications):

- made of durable aluminium
- regulated length
- anti-slip pads

Product features:

- complies with:
 - IEC 61223-3-1
- CE certified
- the Manual provides detailed guidelines for carrying out each test, results assessment and registration

Pro-RF Stand



02-302

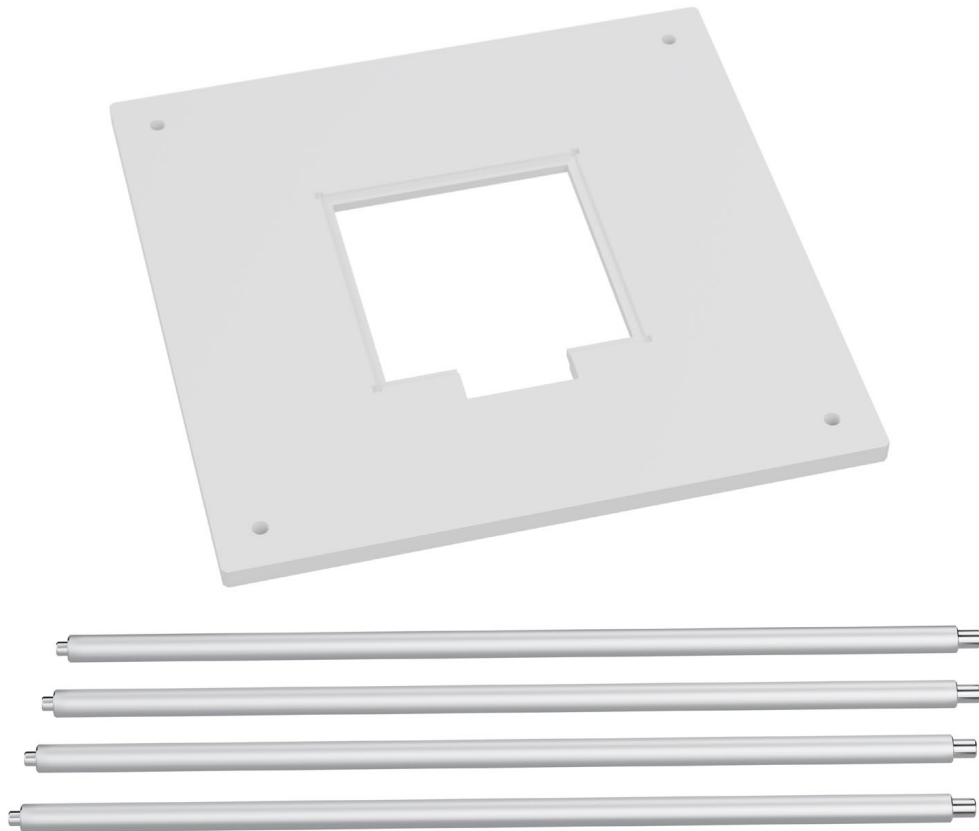

A spacer plate with adjustable legs for positioning Pro-Alpha and Pro-Digi **test phantoms near the X-Ray tube** on units without insertion slots (e.g. over-table / under-table tubes, C-arms etc.).

Technical data (can be modified to customer specifications):

- table top made of PMMA
- legs made of aluminium
- dedicated space for the Pro-RF Al 25 absorption filter

Product features:

- complies with:
 - IEC 61223-3-1
- CE certified
- the Manual provides detailed guidelines for carrying out each test, results assessr

Pro-RF Al 25



02-303



A 25 mm aluminum filter with insertion frame for mounting near the X-Ray tube.

Technical data (can be modified to customer specifications):

- filter dimensions: 120 x 120 x 25 mm
- mounting frame
- made of the purest aluminium
- optional 1 mm thick copper filter (that can be attached to the aluminium) for tests at and above 100 kV (Pro-RF Cu 1) (02-304)
- other sizes of filters upon request

Product features:

- complies with:
 - IEC 61223-3-1
- CE certified
- the Manual provides detailed guidelines for carrying out each test, results assessment and registration



Pro-RF Al 21



02-307



A 21 mm aluminum filter with insertion frame for mounting near the X-Ray tube.

Technical data (can be modified to customer specifications):

- filter dimensions: 120 x 120 x 21 mm
- mounting frame
- made of the purest aluminium
- optional 1 mm thick copper filter (that can be attached to the aluminium) for tests at and above 100 kV (Pro-RF Cu 1) (02-304)
- other sizes of filters upon request

Product features:

- complies with:
 - IEC 61223-3-1
- CE certified
- the Manual provides detailed guidelines for carrying out each test, results assessment and registration



Pro-RF Al 21M



02-308

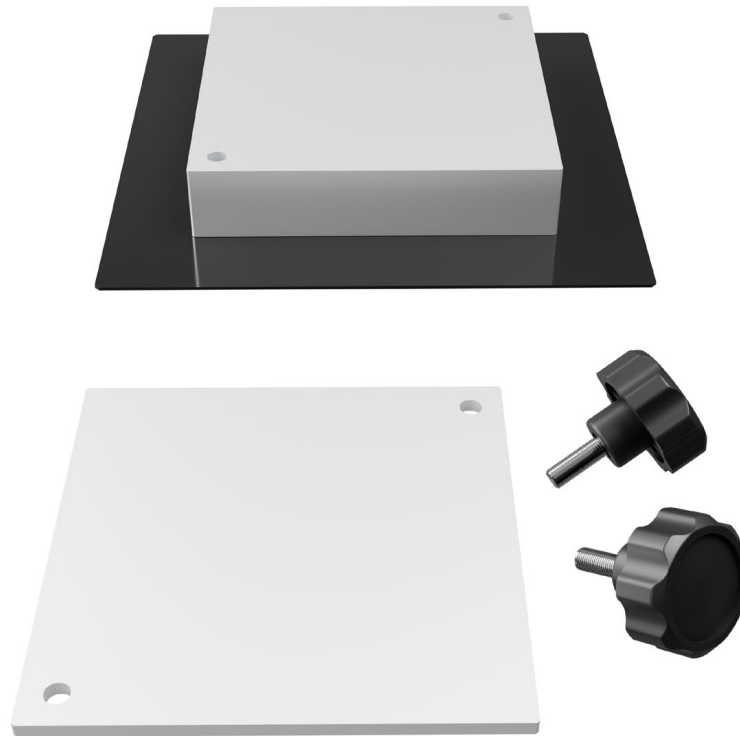

A 2-in-1 solution that allows to get **two attenuation thicknesses with one device: 21 mm or 25mm**. Includes insertion frame for mounting near the X-Ray tube.

Technical data (can be modified to customer specifications):

- filter dimensions: 120 x 120 x 21 mm
- additional 4 mm thick aluminium filter
- mounting frame
- made of the purest aluminium
- two mounting screws included
- optional 1 mm thick copper filter (that can be attached to the aluminium) for tests at and above 100 kV (Pro-RF Cu 1) (02-304)
- other sizes of filters upon request

Product features:

- complies with:
 - IEC 61223-3-1
- CE certified
- the Manual provides detailed guidelines for carrying out each test, results assessment and registration



Pro-RF Fluo 18



02-401

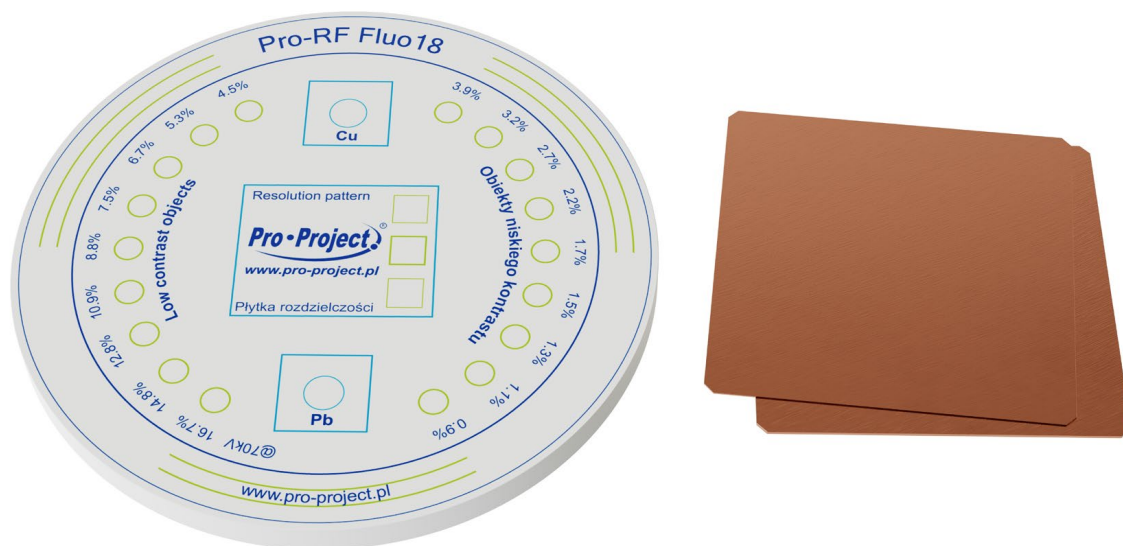

The phantom for evaluation of imaging performance of fluoroscopic systems. It allows **brightness and contrast adjustments, circular geometry check (scanning linearity) plus wide-range low-contrast and high-contrast resolution evaluation.** Available in two standard layouts plus any custom configuration.

Technical data (can be modified to customer specifications):

- diameter: 180 mm
- thickness: 10 mm
- two standard layouts available (others upon request)
- 3 circular rims on the outside of the phantom (\varnothing : 150, 160 and 170 mm) for a geometry and collimation check
- 18 low contrast objects, 8 mm in diameter, producing contrast values from 0.9 to 16.7%
- pattern for line pair resolution evaluation (from 0.6 to 5.0 LP/mm)
- Pb and Cu squares with circular bright and dark objects for contrast and brightness adjustment
- 1.0 and 0.5 mm high purity Cu attenuation filters (fit to the diaphragm housing)
- compact carrying case

Product features:

- complies with:
 - IEC 61223-3-1
 - IPEM Report 91 (2005): Recommended Standards for the Routine Performance Testing of Diagnostic X-Ray Imaging Systems published by the Institute of Physics and Engineering in Medicine
- CE certified
- the Manual provides detailed guidelines for carrying out each test, results assessment and registration

Pro-RF CDR



02-402

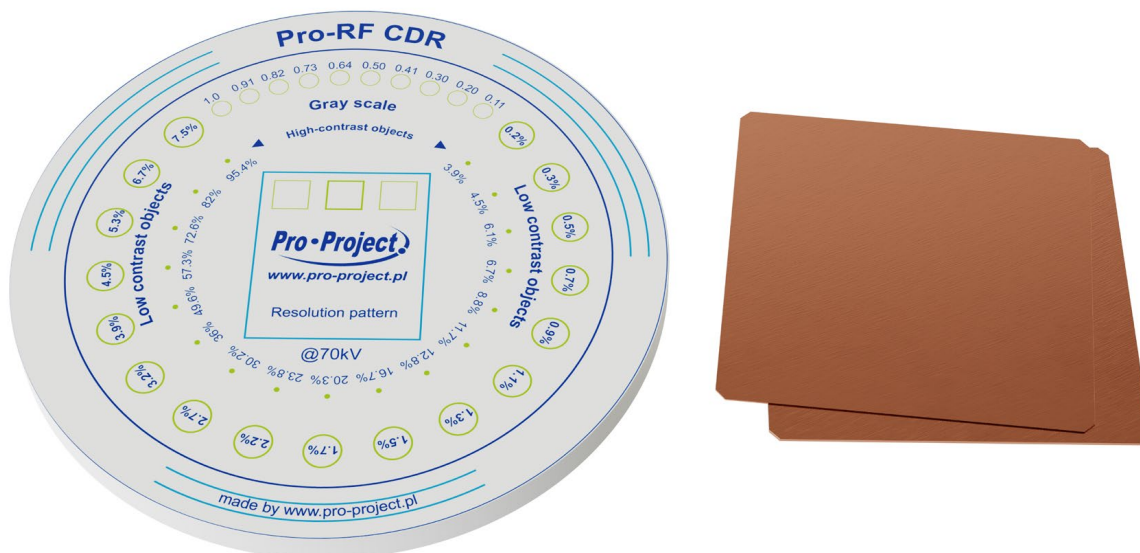

The phantom for evaluation of imaging performance of radiographic systems. It allows **wide-range low-contrast and high-contrast resolution evaluation and sensitometric measurements**. Available in standard layout plus any custom configuration.

Technical data (can be modified to customer specifications):

- diameter: 180 mm
- thickness: 10 mm
- 3 circular rims on the outside of the phantom (\varnothing : 150, 160 and 170 mm) for geometry and collimation check
- 17 low-contrast objects, 11mm in diameter, producing contrast values from 0.2 to 7.5%
- 17 small high-contrast objects, 0.5 mm in diameter, producing contrast values from 3.9 to 95.4%
- 10 sensitometric measurement point details, 5.6 in diameter, producing contrast values from 0.11 to 1.0
- pattern for line pair resolution evaluation (from 0.5 to 14.3 LP/mm)
- 1.0 and 0.5 mm high purity Cu attenuation filters (fits to the diaphragm housing)
- compact carrying case

Product features:

- complies with:
 - IEC 61223-3-1
 - IPEM Report 91 (2005): Recommended Standards for the Routine Performance Testing of Diagnostic X-Ray Imaging Systems published by the Institute of Physics and Engineering in Medicine
- CE certified
- the Manual provides detailed guidelines for carrying out each test, results assessment and registration

Pro-RF Basic Tool



02-502

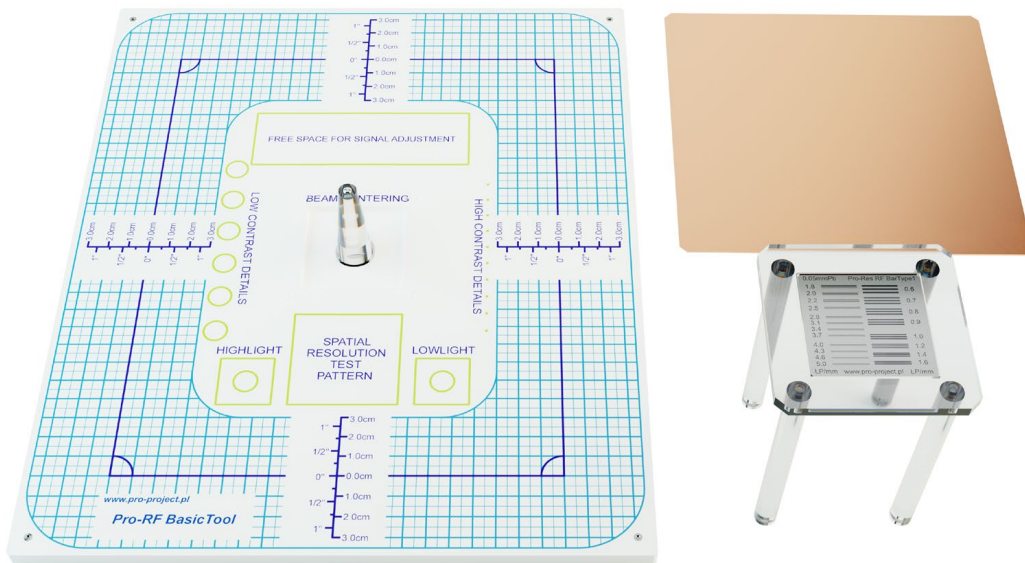

The **Pro-RF Basic Tool** phantom is a compact general radiography image quality testing phantom.

It can be used to do the following tests:

- dynamic range
- geometric distortion
- spatial resolution
- contrast resolution
- beam centring
- focal spot size
- noise/uniformity
- artefacts
- X-ray to light field congruence

Technical data (can be modified to customer specifications):

- outside dimensions: 345 x 290 mm
- high contrast array of 5 and 10 mm uniformly pitched mesh
- highlight and Lowlight details
- 0.6 to 5.0 LP/mm resolution pattern
- 7x 11.0 mm diameter low contrast details
- 11x 0.5 mm diameter high contrast details
- extra stand for the spatial resolution pattern for focal spot size evaluation
- cone for perpendicular X-Ray beam control in the range of $0^\circ \div 1.5^\circ$
- an area of uniform attenuation suitable for noise measurements
- 1 mm Cu filter

Product features:

- complies with:
 - IEC 61223-3-1
- CE certified
- the Manual provides detailed guidelines for carrying out each test, results assessment and registration

Pro-RF MTF



02-107



The edge test device according to IEC 62220-1 for determination of Modulation Transfer Function that consists of a tungsten plate fixed on a lead plate.

Technical data (can be modified to customer specifications):

- overall dimensions: 220 x 110 x 13 mm
- tungsten plate dimensions: 100 x 80 x 1 mm
- lead plate dimensions: 200 x 100 x 3 mm
- tungsten edge scragginess less than 5 μm
- PMMA cover
- three leveling screws

Product features:

- complies with:
 - IEC 62220-1
 - DIN EN 62220-1
 - IEC 62220-1-1:2015
- CE certified
- the Manual provides detailed guidelines for carrying out each test, results assessment and registration

Pro-RF MTF MINI



02-127



The edge test device according to IEC 62220-1 for determination of Modulation Transfer Function.

Technical data (can be modified to customer specifications):

- overall dimensions: 97 x 96 x 9 mm
- tungsten plate dimensions: 50 x 60 x 1 mm
- tungsten plate made from high purity tungsten (< 90%)
- tungsten edge scragginess less than 5 μm
- PCV and PMMA cover
- angular alignment aid

Product features:

- complies with:
 - IEC 62220-1
 - DIN EN 62220-1
 - IEC 62220-1-1:2015
- CE certified
- the Manual provides detailed guidelines for carrying out each test, results assessment and registration

Pro-RF DSA



02-108



A special phantom for Quality Assurance of Digital Subtraction Angiography Equipment (DSA) according to IEC 61223-3-3 and DIN 6868/Parts 8, (2007) and 54. The phantom contains a movable insert with aluminium strips to simulate blood vessels. This insert can be moved via pneumatic system from a safe distance during exposure.

It can be used to measure:

- artifacts
- dynamic range
- logarithmic errors
- contrast media sensitivity

Technical data (can be modified to customer specifications):

- overall dimensions: 200 x 170 x 59 mm
- total PMMA thickness in the test area: 57 mm
- dynamic 7 steps wedge of copper with thicknesses from 0.2 mm to 1.4 mm arranged perpendicular to the longitudinal direction of the insert
- additional step from 1.4 mm to 0.2 mm for compensation test
- additional step from 0.0 mm to 0.2 mm
- movable PMMA insert with 4 aluminum strips (0.05, 0.1, 0.2, 0.4 mm), purity 99.5%, simulating different vascular densities
- pneumatic 6 m hose with a valve allowing for remote movement of the insert in both directions

Product features:

- complies with:
 - IEC 61223-3-3
 - DIN 6868/Parts 8, (2007) and 54
- CE certified
- the Manual provides detailed guidelines for carrying out each test, results assessment and registration

Pro-RF AAPM 15



02-117

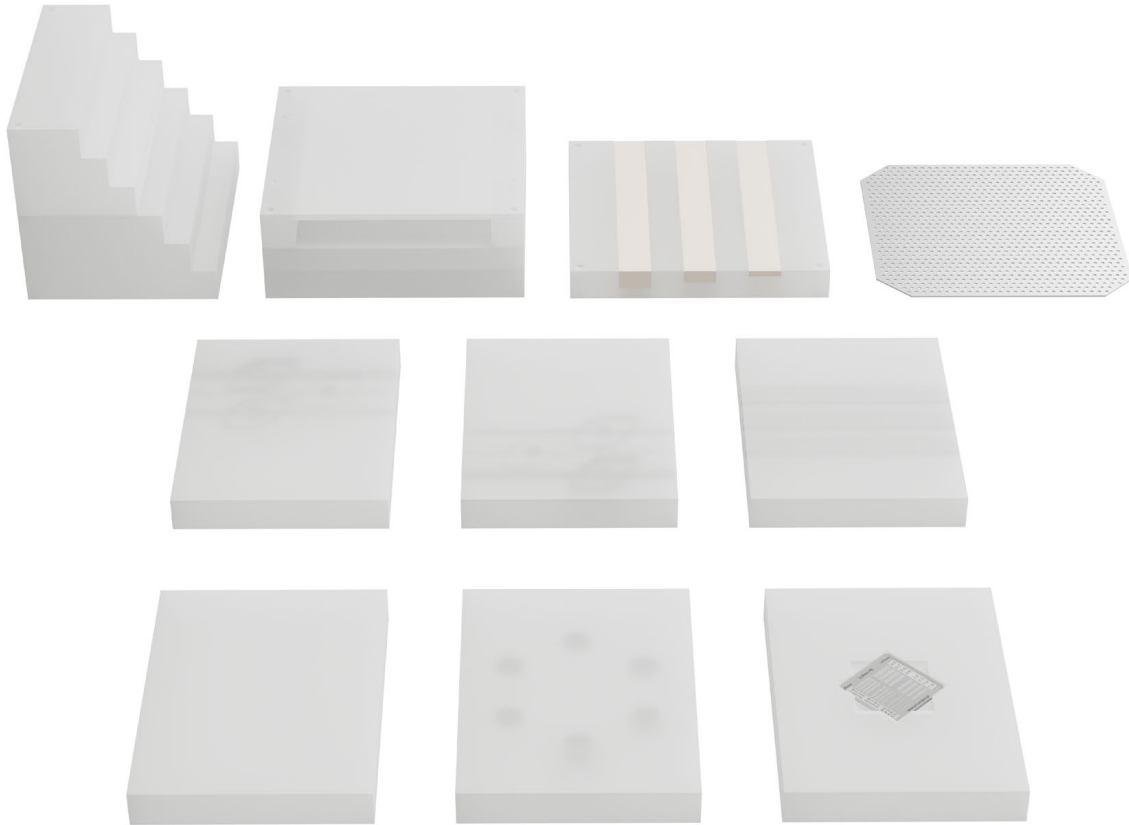

This Digital Subtraction Angiography (DSA) Phantom follows the recommendation in **Report No. 15 by the AAPM (American Association of Physicists in Medicine)** - Digital Radiology/Fluorography Task Group of the Diagnostic X-Ray Imaging Committee. Phantom is designed to **evaluate digital functions of DSA systems** and can be used to check: contrast range, resolution, linearity, uniformity, amplifier dynamic range, registration accuracy and subtraction effectiveness. Its modular construction allows setting up the desired test configuration in a very easy and accurate manner.

Technical data (can be modified to customer specifications):

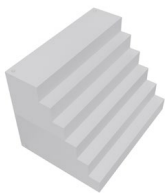

- **Section I and II**

Step Wedge module, 6 step wedges (each 25.4 mm high) to test dynamic range.
Can be folded into 203.2 x 203.2 x 76.5 mm solid block.



- **Section III**

Slot block with a space to fit other test modules.
Outer size: 203.2 x 203.2 x 76.5 mm.
Slot size: 203.2 x 152.4 x 25.4 mm.

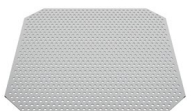

- **Registration Plate**

Made of aluminium with an array of 3.18 mm holes.
Size: 203.2 x 203.2 x 1.5 mm



- **Bone Section**

With three PTFE strips 25 mm in width and 5, 10 and 15 mm in thickness.
Size: 203.2 x 203.2 x 25.4 mm

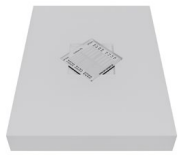

- **High Contrast Resolution Section**

Containing pattern for line pair resolution evaluation (from 0.6 to 5.0 LP/mm).
Thanks to the dedicated recesses, test pattern can be placed in different orientations.
Size: 203.2 x 203.2 x 25.4 mm



- **Blank Insert**

Used with other modules forms a mask plate.
Size: 203.2 x 152.4 x 25.4 mm

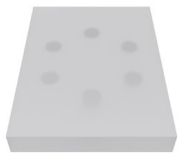

- **Linearity Insert**

Contains 6 iodine areas (19 mm diameter) of different iodine thickness and concentration:
0.5, 1.0, 2.0, 4.0, 10.0 and 20.0 mg/cm².
Size: 203.2 x 152.4 x 25.4 mm

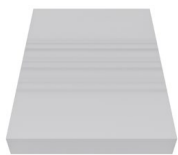

- **Low Contrast Artery Insert**

Containing 3 sets of analogue blood vessel group (diameters 0.5, 1.0, 2.0 and 4.0 mm),
each vessels group includes different iodine concentrations: 2.5, 5.0 and 10.0 mg/cc.
Size: 203.2 x 152.4 x 25.4 mm

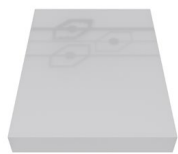

- **150mg/ml Iodine Artery Insert**

3 sets of analogue blood arteries (thickness 1.0, 2.0, 4.0 mm) each includes arteriarctial
and arterial aneurysm whose sizes are 1/4, 1/2 and 3/4 of artery diameter.
Size: 203.2 x 152.4 x 25.4 mm



- **300mg/ml Iodine Artery Insert**

3 sets of analogue blood arteries (thickness 1.0, 2.0, 4.0 mm) each includes arteriarctia
and arterial aneurysm whose sizes are 1/4, 1/2 and 3/4 of artery diameter.
Size: 203.2 x 152.4 x 25.4 mm

- **Carrying Case**

Product features:

- complies with:
 - AAPM Report No. 15 - Performance Evaluation and Quality Assurance in Digital Subtraction Angiography - Diagnostic X-Ray Imaging Committee/Digital Radiography/ Fluorography Task Group - May 1985
 - IEC 61223-3-1
- CE certified
- the Manual provides detailed guidelines for carrying out each test, results assessment and registration

Pro-RF Geometry



02-105 - Pro-RF Geometry Cone
02-106 - Pro-RF Geometry Cylinder

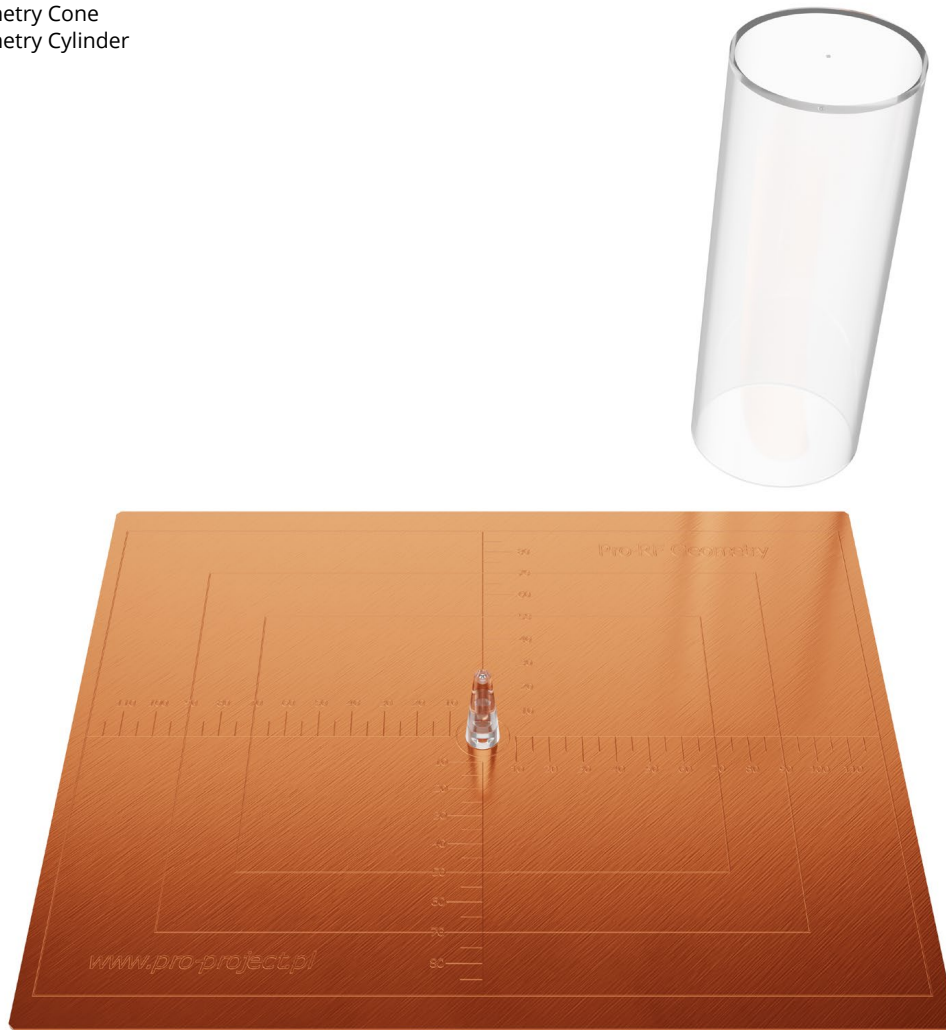

This device readily indicates a 1% or 2% misalignment at a 1 m focal-film distance (FFD), but it can be used at any FFD. It consists of a flat 20 x 25 cm plate with a 14 x 18 cm pattern etched on its surface. It can also be used to check fluoroscopy alignment and collimation.

A steel ball is mounted in the center of a disc at each end of the 15 cm high clear plastic cylinder. When the balls are positioned over one another and at the right angle to the film, their images will appear as one if the central ray is truly perpendicular to the film. The approximate degree of improper angulation can also be determined.

Technical data (can be modified to customer specifications):

- dimensions: 200 x 250 mm
- copper plate with engraved 5mm scale
- 150 x 60 mm cylinder with a steel ball embedded in the center of its bases – beam alignment
- cone for the perpendicular X-Ray beam control in the range of $0^\circ \div 1.5^\circ$ (option, instead of the cylinder – for simpler measurements)

Product features:

- complies with:
 - IEC 61223-3-3
- CE certified
- the Manual provides detailed guidelines for carrying out each test, results assessment and registration



Pro-RF Ruler

- 02-601 - PMMA ruler with the radiopaque scale - 50 cm / 2 mm scale
- 02-602 - PMMA ruler with the radiopaque scale - 50 cm / 1 mm scale
- 02-603 - aluminium ruler with the radiopaque scale - 50 cm / 2 mm scale
- 02-604 - aluminium ruler with the radiopaque scale - 50 cm / 1 mm scale
- 02-605 - two PMMA rulers with the radiopaque scale joined in the middle (cross)- 40 cm each / 1 mm scale

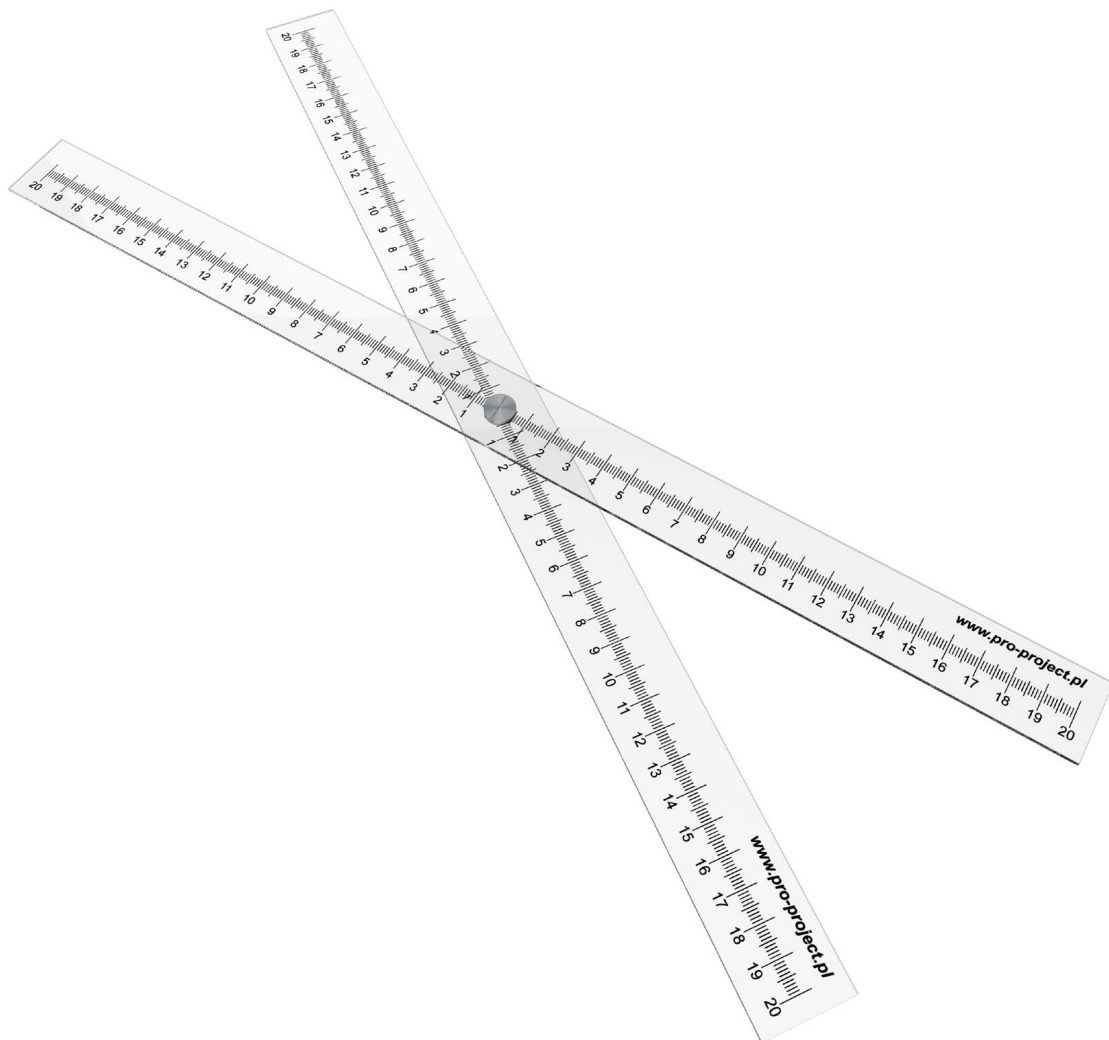

The radiopaque ruler in the image provides a permanent reference of image size. It can be used to check the accuracy and position of the light field for quality control and adjustment as well as be included during x-ray procedures, leaving a clear measurement right on the x-ray image itself.

Technical data (can be modified to customer specifications):

We manufacture many sizes and types of radiopaque rulers for many applications, with different scales and accuracy. Please contact us to find the best solution for you.

Product features:

- complies with:
 - IEC 61223-3-1
- CE certified
- the Manual provides detailed guidelines for carrying out each test, results assessment and registration

Pro-RF AlphaG



02-114

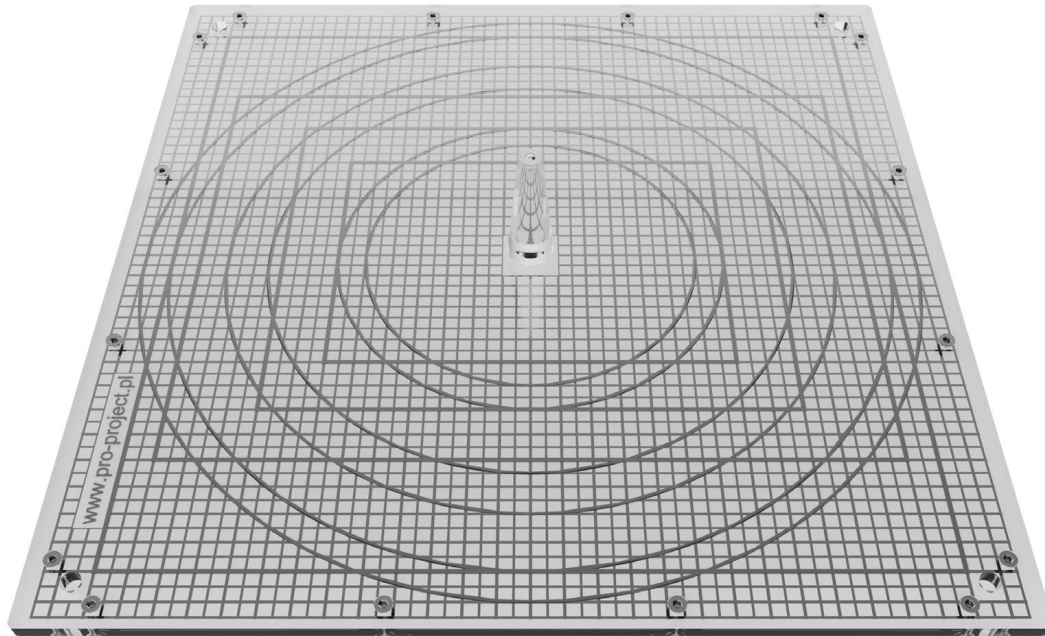

The Pro-AlphaG phantom is a simple tool to check geometry of the R/F system:
collimation / beam alignment and position and size of the effective radiation field.

Technical data (can be modified to customer specifications):

- dimensions: 308 x 308 x 11 mm
- lead mesh pattern (5 mm scale) engraved in PMMA plate secured with transparent cover
- markings to determine the size and position of the effective radiation field
- cone for the perpendicular X-Ray beam control in the range of $0^\circ \div 1.5^\circ$

Product features:

- complies with:
 - IEC 61223-3-1
 - DIN 6868/3 and DIN 6868/4
- CE certified
- the Manual provides detailed guidelines for carrying out each test, results assessment and registration

Pro-RF Tomo



02-116

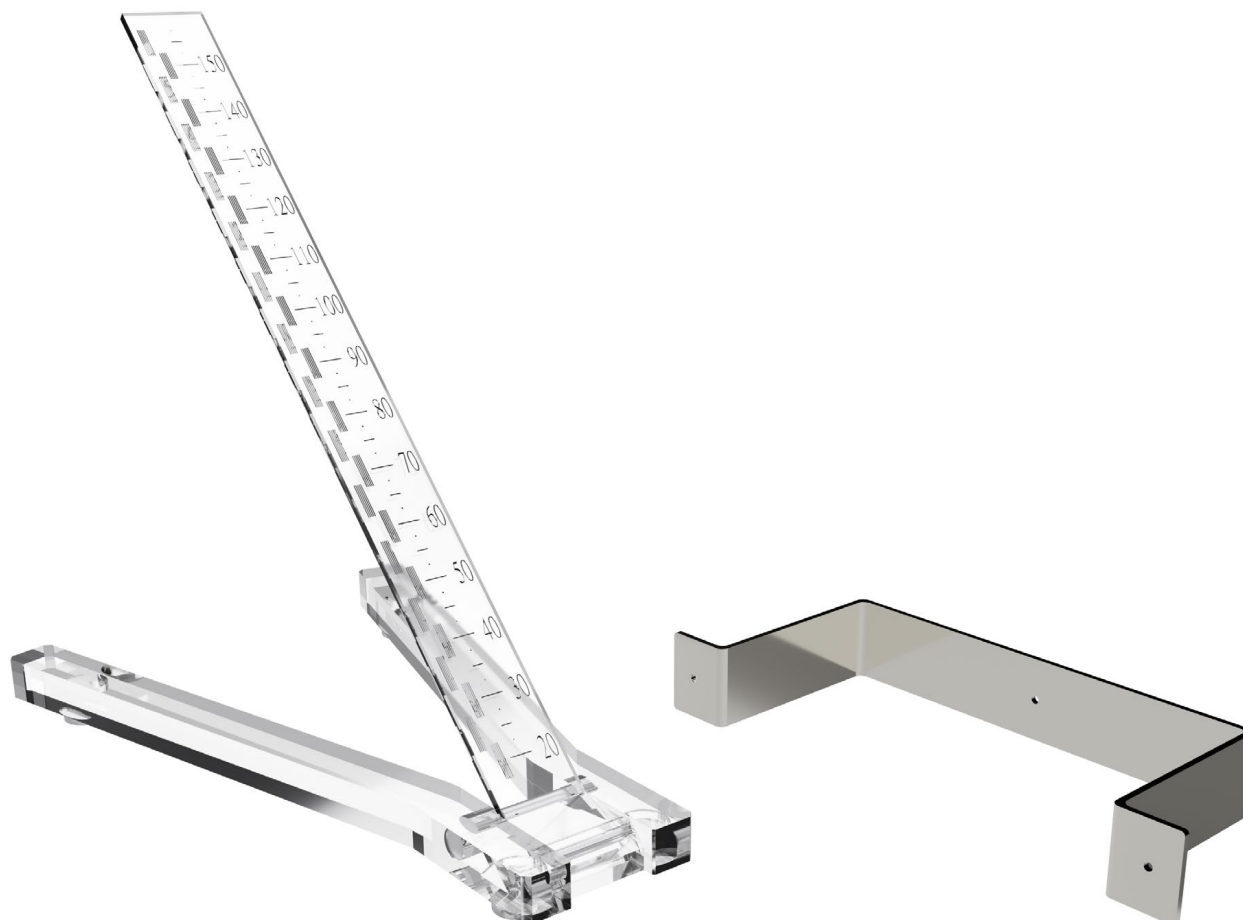

A set of simple tools dedicated for measurements on tomography X-Ray equipment.

It can be used for the layer height adjustment and tomography movement tests.

Technical data (can be modified to customer specifications):

- 160 mm ruler made of PMMA with engraved detailed X-Ray opaque scale
- ruler can be folded to a very compact size for easy transportation
- stainless steel step with holes for displaying tomographic movement

Product features:

- complies with:
 - IEC 61223-3-1
- CE certified
- the Manual provides detailed guidelines for carrying out each test, results assessment and registration

Pro-RF Res 150



02-120



The phantom for acceptance and constancy testing of **Cone-Beam CT / Volume Tomography (DVT) in fluoroscopy** according to **DIN 6868-150**.

Technical data (can be modified to customer specifications):

- dimensions: 120 x 120 mm
- 10 mm thick test module containing sets of cylindrical holes, parallel to Z-Axis, of 0.5, 0.6, 0.7, 0.8, 0.9, 1.0 and 1.3 mm diameters
- two additional 25 mm PMMA plates

Product features:

- complies with:
 - DIN 6868 – 150
- CE certified
- the Manual provides detailed guidelines for carrying out each test, results assessment and registration

Pro-RF GridAlign



02-113

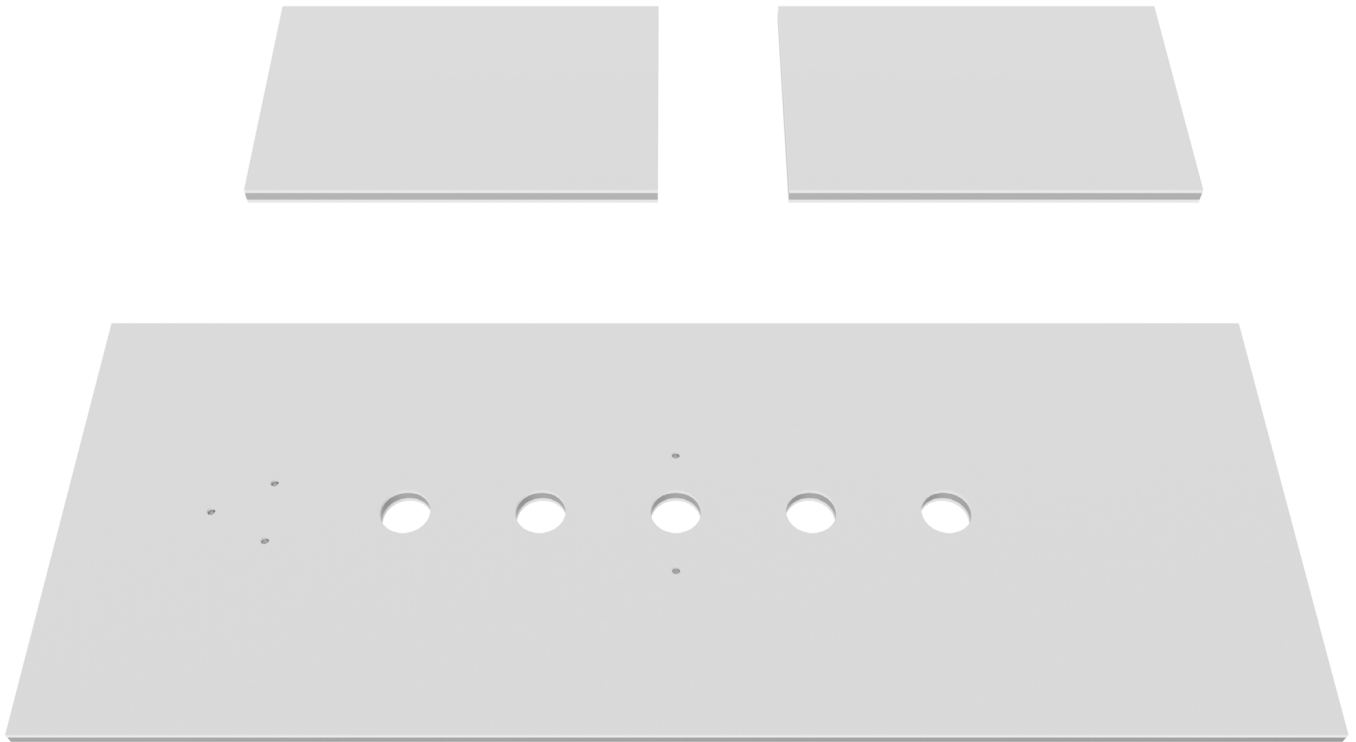

This device **improves alignment of the radiographics and central beam of the x-ray tube.** It is designed to test proper grid alignment with respect to the central beam.

Technical data (can be modified to customer specifications):

- main plastic covered lead blocker
- dimensions: 90 x 230 x 2 mm
- five larger holes have centers spaced 25 mm apart (allow test exposures to a film cassette)
- smaller holes provide marking to show the tool orientation
- two additional small lead blockers

Product features:

- complies with:
 - IEC 61223-3-1
- CE certified
- the Manual provides detailed guidelines for carrying out each test, results assessment and registration

Pro-RF Contact



02-104

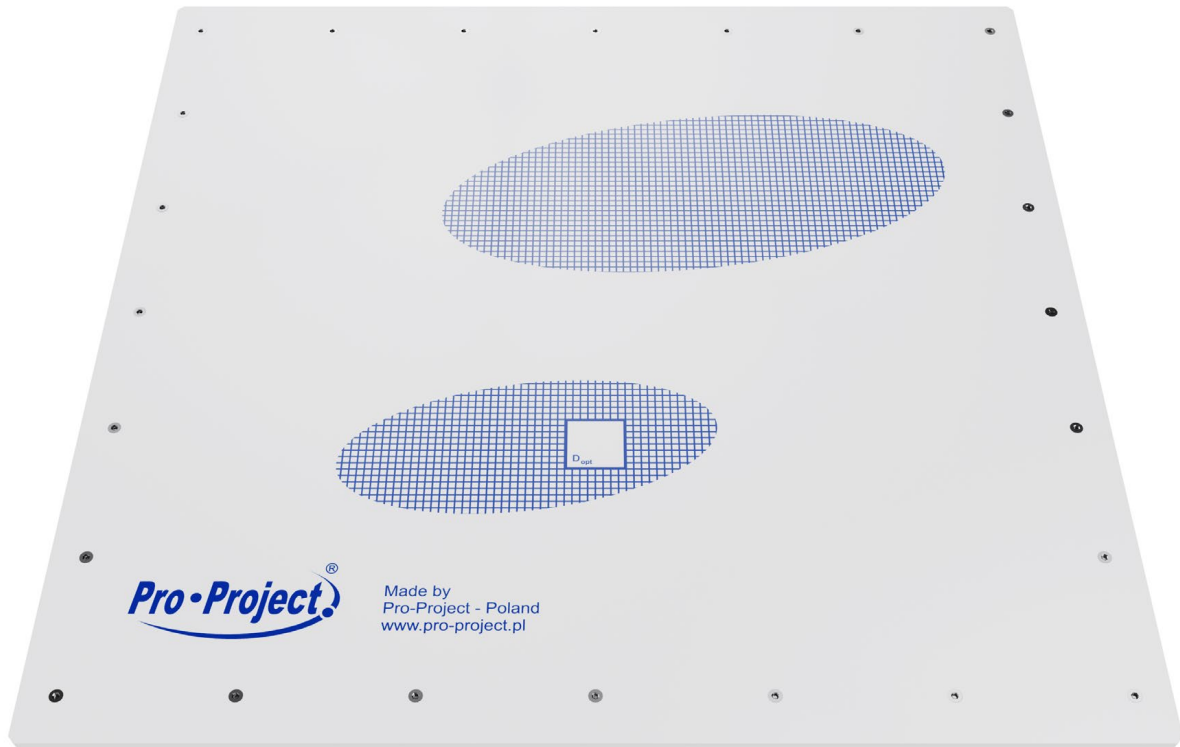

A test grid for **testing cassette film – screen contact**.

Technical data (can be modified to customer specifications):

- dimensions: 430 x 450 x 8 mm
- 25 x 25 mm free field to measure optical density
- mesh size: 3.15 mm
- wire diameter: 0.71 mm

Product features:

- complies with:
 - IEC 61223-3-1
- CE certified
- the Manual provides detailed guidelines for carrying out each test, results assessment and registration

Pro-RF Contrast



02-109

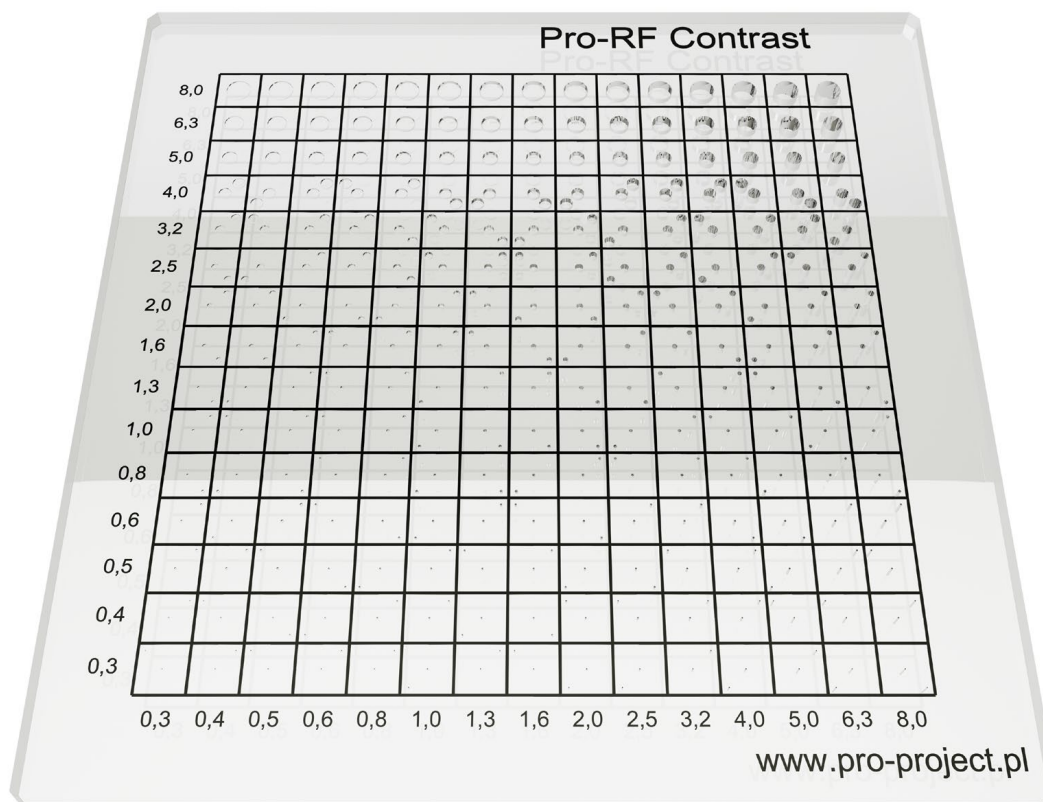

The Contrast-Detail (CD) phantom makes it possible to quantify both **detail and contrast as observed by the radiologist**. It can be used within the **entire range of radiography** diagnostic imaging systems, such as fluoroscopy and angiography. It has **405 holes** that generate subtle changes in contrast.

Technical data (can be modified to customer specifications):

- dimensions: 265 x 265 x 10 mm
- made of PMMA
- 15 columns and 15 rows of holes
- two cylindrical holes for each combination, except for the first 3 rows with the largest diameters
- diameters of holes range from 0.3 to 8.0 mm
- depths of holes range from 0.3 to 8.0 mm
- tolerance of hole measurements is at least 0.01 mm
- all markings on the phantom are opaque for X-rays
- available in rectangular and circular shapes
- additional Cu filters for different attenuation combinations
- optional carrying case (02-110)

Product features:

- complies with:
 - IEC 61223-3-1
- CE certified
- the Manual provides detailed guidelines for carrying out each test, results assessment and registration

Pro-RF XR21



02-220

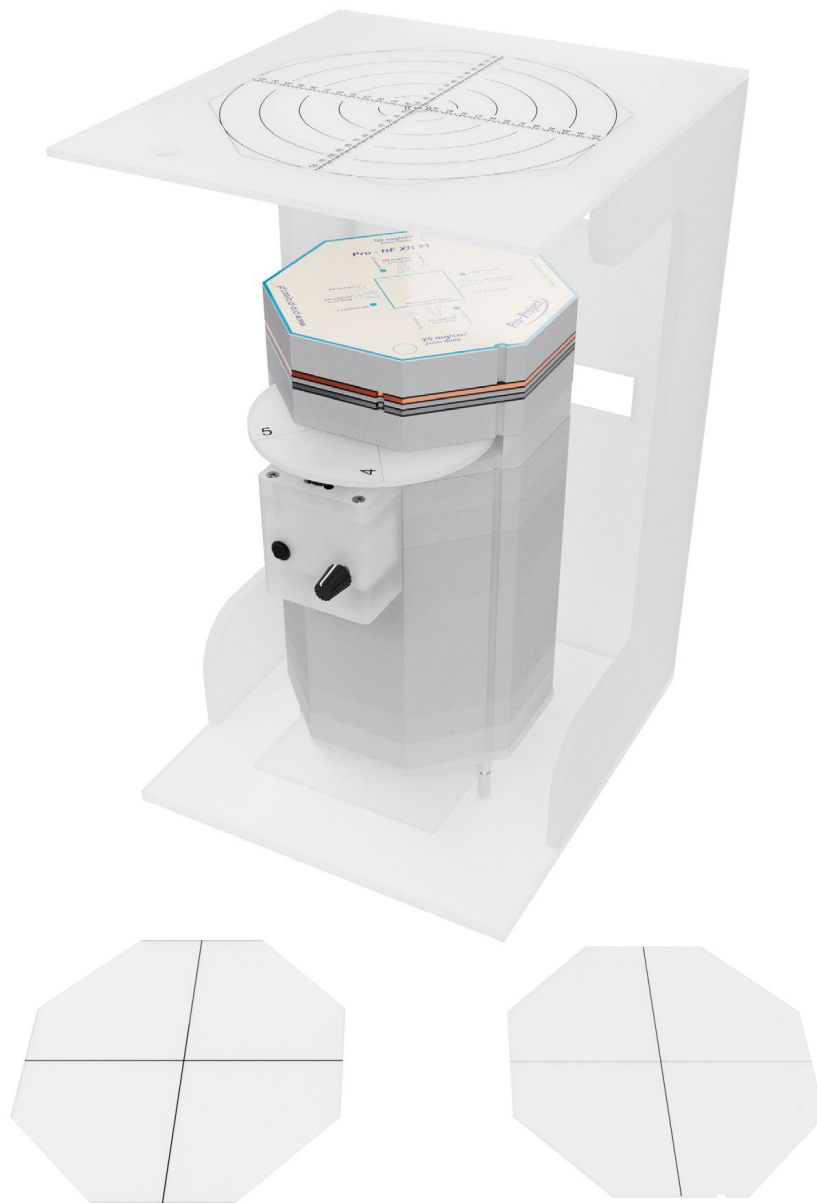

The phantom has been designed in accordance with the NEMA XR21 standard. This modular phantom made of PMMA consists of several plates allowing variation of phantom thickness setup in steps of 25 mm, up to a total of 300 mm, simulating a range of patient sizes.

It can be used to measure:

- collimation / beam alignment
- position and size of the effective radiation field
- dynamic range
- spatial resolution
- contrast resolution
- homogeneity
- beam quality



Technical data (can be modified to customer specifications):

- central target assembly - 1 piece
- WTR plate A - 25 mm test object - 1 piece
- WTR plate B - 25 mm plate with Al and Air cylinders - 1 piece
- WTR plate C - 25 mm plate with Al and Air cylinders - 1 piece
- WTR plate D - 25 mm plate with Air cylinders - 3 piece
- WTR plate E - 25 mm plate with Air cylinders - 1 piece
- blank 25 mm PMMA plate with alignment parts - 4 pieces
- field size plate - 1 piece
- alignment target for test stand - 1 piece
- alignment cross for test stand - 1 piece
- alignment target for small base - 1 piece
- alignment cross for small base - 1 piece
- rotating target assembly - 1 piece
- test stand - 1 piece
- small base - 1 piece
- 3 mm thick lead plate with laminate - 1 piece
- 2 mm thick copper plate with laminate - 1 piece
- alignment pins (including spares) - 100 pieces
- heavy duty carrying case



Product features:

- complies with:
 - NEMA Standards Publication (NU 1-2001) Performance Measurements of Scintillation Cameras
 - NEMA Standards Publication (NU 1-2012) Performance Measurements of Scintillation Cameras
 - AAPM Report No. 15 - Performance Evaluation and Quality Assurance in Digital Subtraction Angiography - Diagnostic X-Ray Imaging Committee/Digital Radiography/ Fluorography Task Group
 - Report NO. 60 Instrumentation Requirements of Diagnostic Radiological Physicists
 - Report NO. 31 by the American Association of Physicists in Medicine (AAPM)
- CE certified
- the Manual provides detailed guidelines for carrying out each test, results assessment and registration

Pro-RF HighRes



02-112 - 16-60 version
02-111 - 60-150 version

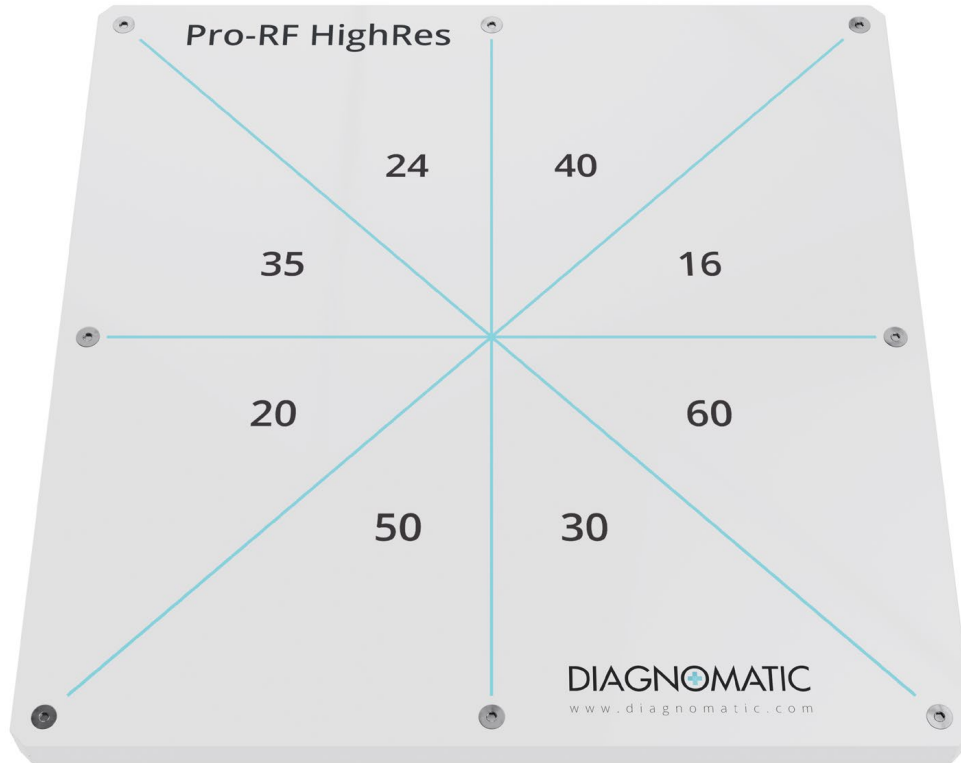

The test phantom for **evaluation of high contrast resolution of fluoroscopy system in one exposition**. It consists of eight patterns of wire mesh in a pie shape.

Technical data (can be modified to customer specifications):

- dimensions: 180 x 180 x 10 mm
- cover made of PMMA
- two standard configurations of high contrast wire mesh patterns:
 - for standard systems: 16, 20, 24, 30, 35, 40, 50, 60
 - for higher resolution systems: 60, 70, 80, 90, 100, 110, 120, 150

Product features:

- complies with:
 - IEC 61223-3-1
- CE certified
- the Manual provides detailed guidelines for carrying out each test, results assessment and registration

Pro-RF FluoCDRH



02-207

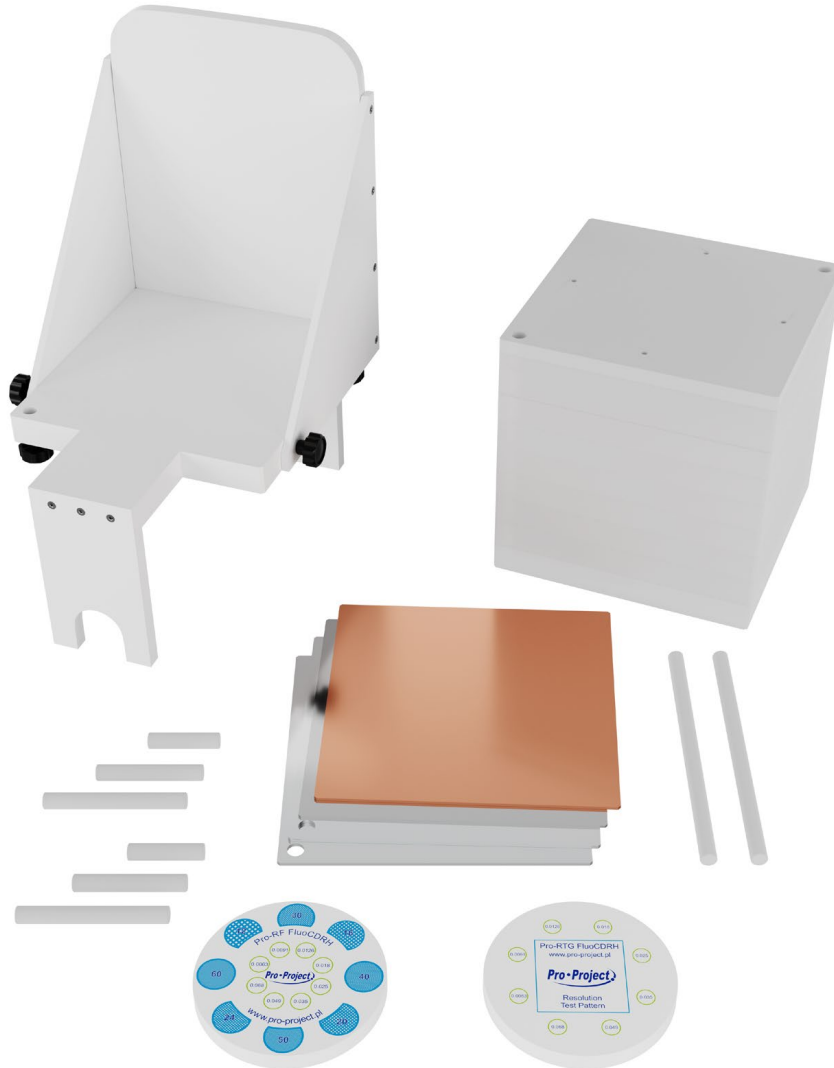

The compact and easy to use phantom for performance evaluation of fluoroscopic systems according to Center for Devices and Radiological Health (CDRH) specifications. It also meets recommendations of AAPM Report No. 60 "Instrumentation Requirements of Diagnostic Radiological Physics". It is optimized for both under- and over-table fluoroscopic tubes.

Technical data (can be modified to customer specifications):

- set of acrylic plates making total thickness of 193 mm
- thanks to modular construction different total thicknesses can be easily set up
- size of acrylic plates is 177.8 x 177.8 mm
- 2x 2.3 mm aluminium filters can be screwed underneath the acrylic plates
- four beads embedded on the top plate can be used as orientation points for collimation setup
- phantom stands on two legs 100 mm above tabletop
- one leg is a probe holder
- back plate with a handle can be easily unscrewed for over-table measurements
- additional 1.6 mm copper filter simulates the presence of a 2 mm thick layer of barium sulfate, and can be used to measure the air kerma rate (free in air)
- 3.2 mm lead plate simulates maximum attenuation, and can be used to measure the maximum air kerma rate (free in air)
- two types of a fluoroscopic image quality test object containing 8 low-contrast holes in an aluminium disc and 8 high contrast meshes or a high contrast resolution lead plate (from 0.6 to 5.0 LP/mm).
- heavy duty carrying case



Under-table set up

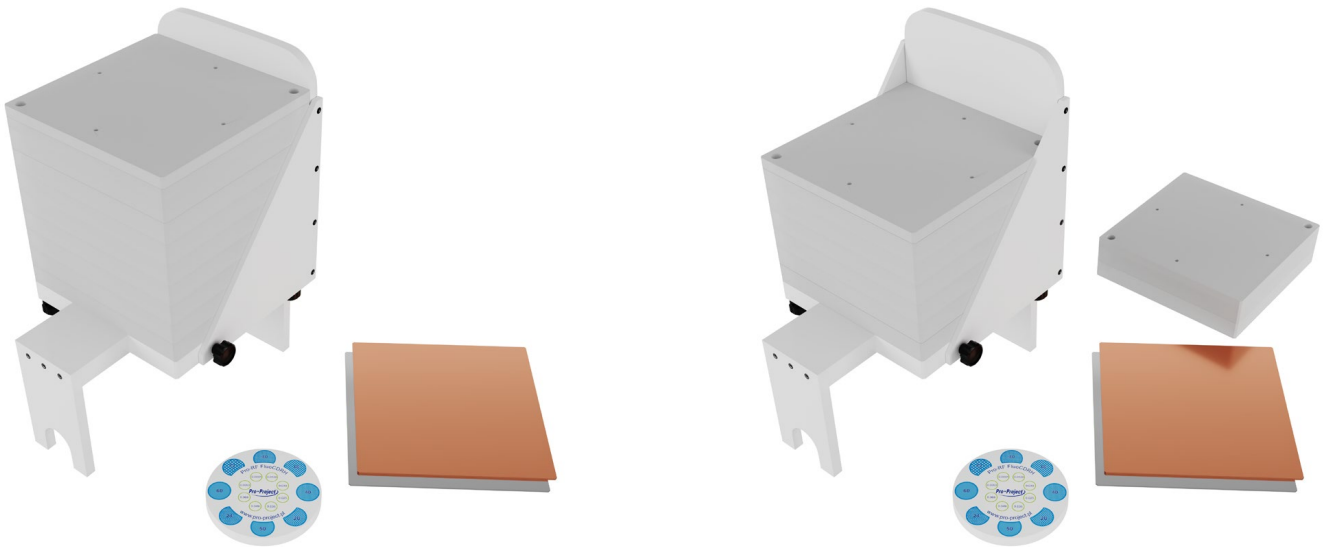

Over-table set up

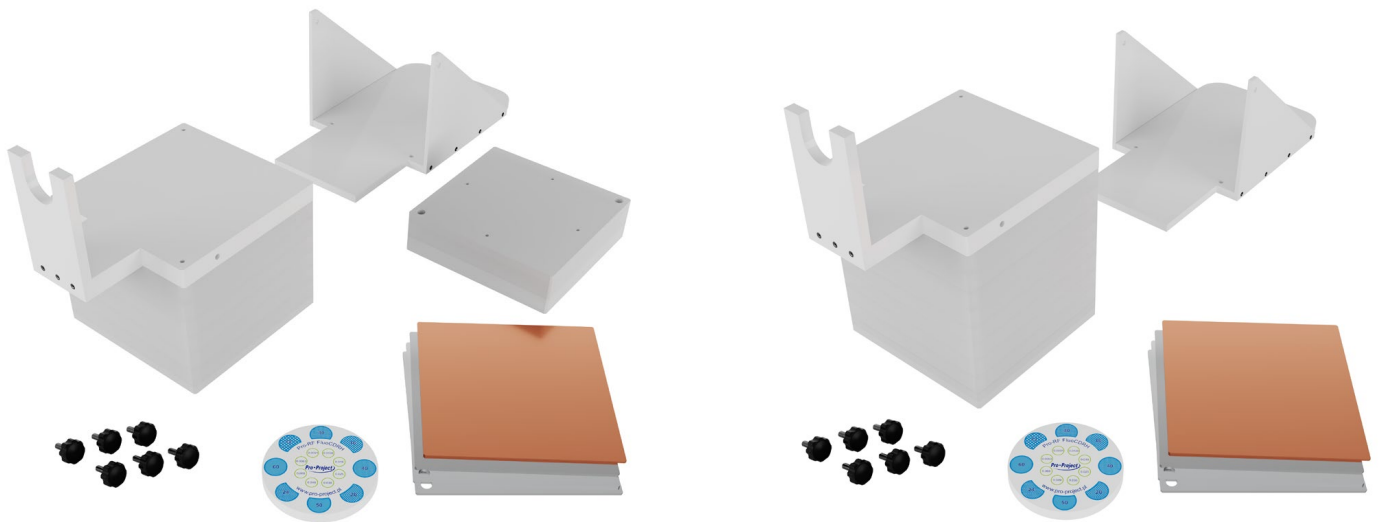

Product features:

- complies with:
 - Nationwide Evaluation of X-ray Trends (NEXT) Protocol for 2003 Survey of Fluoroscopic X-Ray Systems
 - IEC 61223-3-1
 - AAPM Report No. 60 “Instrumentation Requirements of Diagnostic Radiological Physics”
- CE certified
- the Manual provides detailed guidelines for carrying out each test, results assessment and registration

Pro-RF ChestCDRH



02-211



The compact and easy to use phantom designed to invoke a response of automatic-exposure. Follows the Center for Devices and Radiological Health (CDRH) specifications of a chest phantom and AAPM recommendations from Report No. 31 "Standardized Methods for Measuring Diagnostic X-Ray Exposure". The adult chest phantom approximates a 173 cm adult weighing approximately 165 lbs with an anterior-posterior (AP) thickness of about 23 cm. The anatomical region the phantom simulates is the lung field, and therefore contains an air gap within the center. The phantom is composed of polymethyl-methacrylate (PMMA).

Technical data (can be modified to customer specifications):

- set of acrylic and aluminium plates mounted on a frame with chamber holder
- approximates a 173 cm adult weighing approximately 165 lbs with an anterior-posterior (AP) thickness of about 23 cm
- 254 x 254 mm pieces of 1100 alloy and clear PMMA with 19.0 mm air gap
- the order of filters is: 9.5 mm PMMA, 2.5 mm Al, 54 mm PMMA, 19.0 mm Air, 1.6 mm Al, 9.5 mm PMMA
- heavy duty carrying case

Product features:

- complies with:
 - report No. 31 "Standardized Methods for Measuring Diagnostic X-Ray Exposure"
- CE certified
- the Manual provides detailed guidelines for carrying out each test, results assessment and registration

Pro-RF AAPM 31



02-205



A set of acrylic and aluminium filters for testing diagnostic X-rays according to **AAPM recommendations from Report No. 31** "Standardized Methods for Measuring Diagnostic X-Ray Exposure". Patient-equivalent acrylic and aluminium phantoms provide the necessary attenuation between the source and AEC or ABC detectors.

Technical data (can be modified to customer specifications):

- 5x acrylic plate 250 x 250 x 25.4 mm
- 1x acrylic plate 250 x 250 x 50.8 mm
- 1x 250 x 250 x 1 mm aluminium filter
- 1x 250 x 250 x 2 mm aluminium filter
- 1x 70 x 250 x 4.5 mm aluminium filter
- 4x positioning rod
- 4x 50.8 mm spacer tube
- optional heavy-duty transport case (02-206)

Product features:

- complies with:
 - report No. 31 "Standardized Methods for Measuring Diagnostic X-Ray Exposure"
- CE certified
- the Manual provides detailed guidelines for carrying out each test, results assessment and registration

Pro-RF AEC PMMA



02-201 - 240 x 240 mm version
02-221 - 300 x 300 mm version
02-221-15 - 300 x 300 mm, 15 cm stack version

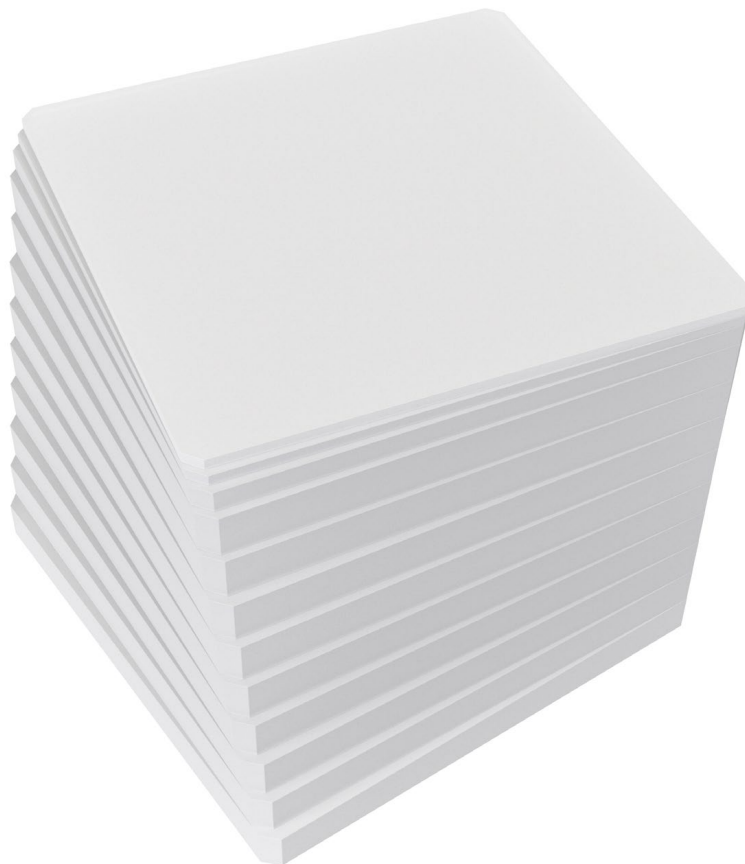

A set of acrylic plates for testing Automated Exposure Control of radiography equipment.

Technical data (can be modified to customer specifications):

- made of transparent PMMA
- optional 99.5% purity 240 x 240 x 25 mm aluminium plate (02-202)
- optional holder for stabilizing PMMA panels vertically
- optional carrying case

Available configurations:

- Pro-RF AEC PMMA (02-201) - 240 x 240 mm (9x 20 mm, 1x 10 mm, 2x 5 mm)
- Pro-RF AEC PMMA (02-221) - 300 x 300 mm (9x 20 mm, 1x 10 mm, 2x 5 mm)
- Pro-RF AEC PMMA (02-221-15) - 300 x 300 mm (7x 20 mm, 1x 10 mm)
- thickness tolerance +/- 10%
- other sizes of filters upon request

Product features:

- complies with:
 - IEC 61223-3-1
- CE certified
- the Manual provides detailed guidelines for carrying out each test, results assessment and registration

Pro-RF AEC Cu



02-203



A set of high purity copper plates for testing Automated Exposure Control of radiography equipment. It can be mounted near the X-Ray tube and used instead of PMMA plates.

Technical data (can be modified to customer specifications):

- dimensions: 169 x 176 mm
- 1x 1.0 mm thick
- 1x 0.5 mm thick
- made of high purity copper
- other sizes of filters upon request

Product features:

- complies with:
 - IEC 61223-3-1
- CE certified
- the Manual provides detailed guidelines for carrying out each test, results assessment and registration

Pro-RF FocalSpot



02-501



A simple test device for the focal spot size evaluation. It consists of a precision bar pattern placed at the end of the cylinder that provides accurate and reproducible target-to-image receptor spacing.

Technical data (can be modified to customer specifications):

- cylinder dimensions: 152,4 x Ø76 mm
- bar pattern mounted on the top of the cylinder
- 8 resolution bar patterns ranging from 0.84 to 5,66 LP/mm

Product features:

- complies with:
 - IEC 61223-3-1
- CE certified
- the Manual provides detailed guidelines for carrying out each test, results assessment and registration

Pro-RF 21 Steps



02-305

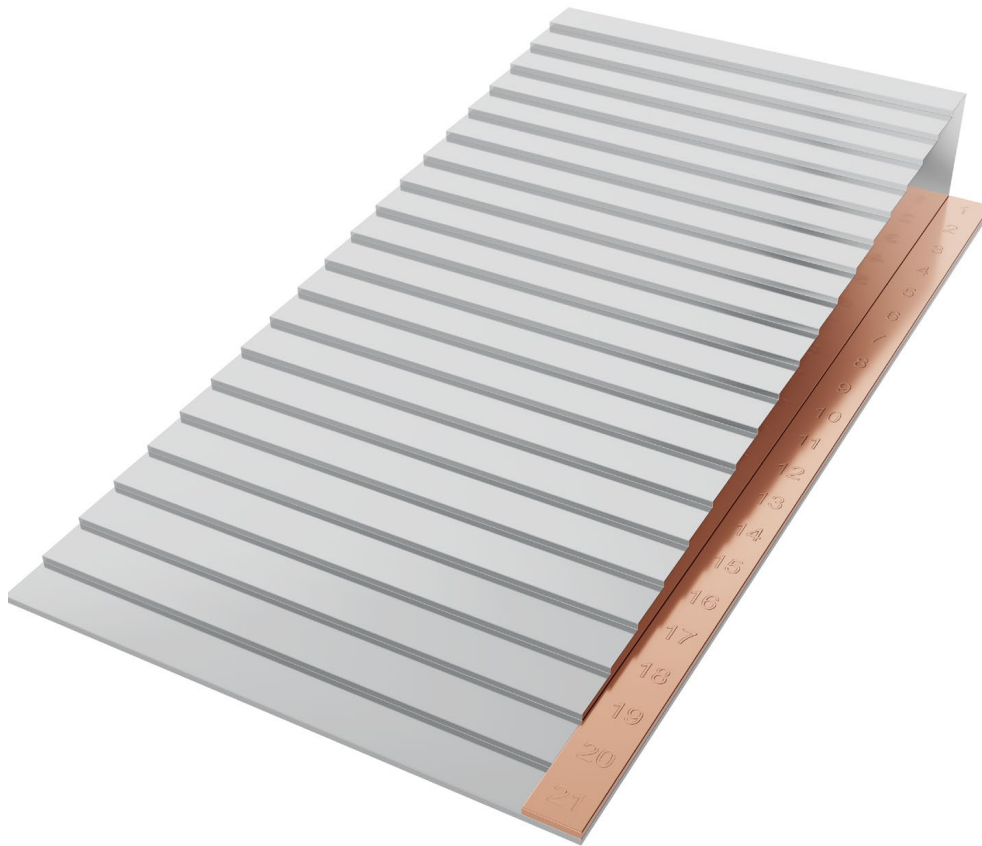

A 21 step aluminium wedge for determination of the **dose reproducibility and sensitometric curve shape, speed and mid-gradient** of X-Ray screen-film radiography systems.

Technical data (can be modified to customer specifications):

- dimensions: 231 x 110 x 31.5 mm
- 21 steps with a width of 11 mm
- 1.5 mm graduation per step
- made of a highest purity aluminium
- copper numbers marking each step
- other sizes of step wedges upon request

Product features:

- complies with:
 - IEC 61223-3-1
- CE certified
- the Manual provides detailed guidelines for carrying out each test, results assessment and registration

Pro-RF 11 Steps



02-306

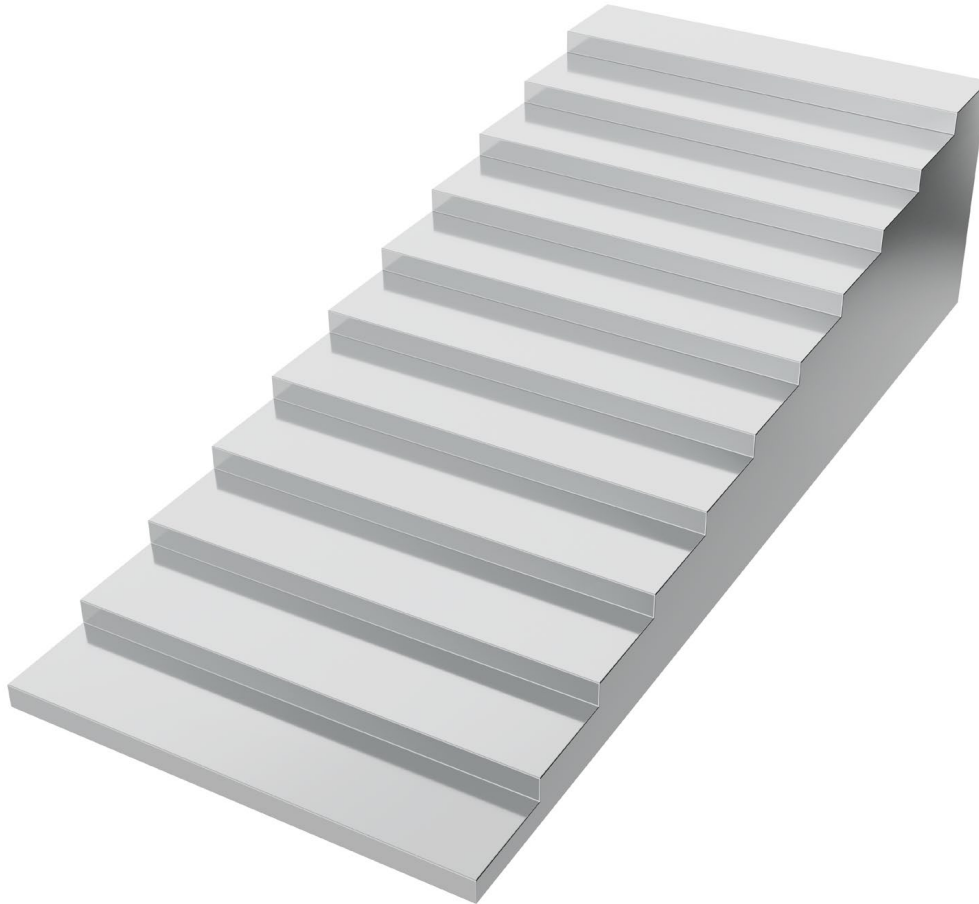

A 11 step aluminium wedge for evaluation of **dynamic range of digital or film-screen systems.**

Technical data (can be modified to customer specifications):

- dimensions: 140 x 60 x 35.2 mm
- 11 steps 3.2 mm high and 12.7 mm deep
- made of a highest purity aluminium
- other sizes of step wedges upon request

Product features:

- complies with:
 - IEC 61223-3-1
- CE certified
- the Manual provides detailed guidelines for carrying out each test, results assessment and registration



DIAGNOMATIC

www.diagnostic.com

World Headquarters

Kwiatowa 43A Street
22-105 Okszw, Poland
E-mail: contact@diagnostic.com
Phone: +48 668 024 874, +48 606 161 554

US office

8400 West Sunset Road
Black Fire Innovation Center, Suite 300
Las Vegas, NV 89113, USA
E-mail: contact.us@diagnostic.com
Phone: +1 (480) 799-7317

Distributor

