

# Agilent DC Power Analyzer

Models: N6705A, N6715A, N6705B, N6715B, N6731B-36B, N6741B-46B, N6751-54A, N6761A-62A, N6773A-76A, N6781A-82A

## Technical Overview



*See insights into power consumption never seen before with Agilent's new 2-quadrant source/measure units (SMUs) and 14585A control and analysis software*

For details visit  
[www.agilent.com/find/N6700](http://www.agilent.com/find/N6700)  
[www.agilent.com/find/14585](http://www.agilent.com/find/14585)

- Ideal for R&D testing and design validation
- Sources and measures DC voltage and current into your device under test
- Combines 1 to 4 DC power supplies, DMM, oscilloscope, arbitrary waveform generator, and datalogger in 1 integrated instrument
- Saves time – no programming required
- Eliminates need to gather and configure multiple instruments
- Flexible, modular system: Can mix and match DC source power levels and measurement performance levels to optimize investment
- Connect via GPIB, LAN, or USB
- Fully compliant to LXI Class C specification 

*For Power Solutions in ATE – See back cover*

## R&D Engineers are Under Time Pressure

Due to increasing time-to-market pressures, research and development engineers often find themselves on tight schedule to work through device under test (DUT) testing. Along with being driven faster, the R&D engineers can face a high regret factor should their haste result in damaging scarce, complex or expensive DUTs during product development. This is a particular concern when tests involve applying DC power to a DUT. Furthermore, test complexity increases when testing devices that require multiple input voltages, such as printed circuit boards.

Today, when performing DC power-related tests, R&D engineers must gather and configure multiple instruments to complete DC sourcing and measurement tasks. When executing these complex tasks, which can involve simultaneously connecting to and physically interacting with multiple test instruments, the risk of error increases. In response, R&D engineers may choose to automate tests that are too complex to do manually. Unfortunately, while automating tasks reduces human error, writing and debugging programs adds more work to already overloaded R&D engineers.

## New Instrument Category for R&D Engineers to Increase Productivity

The Agilent N6705 DC Power Analyzer represents an entirely new instrument category for R&D engineers. It provides unrivaled productivity gains when sourcing and measuring DC voltage and current **into** a DUT. Using the Agilent N6705 DC Power Analyzer, R&D engineers can gain insights into the DUT's power consumption in minutes without writing a single line of code. It provides an easy-to-use interface, with all sourcing and measuring functions available from the front panel.

### **The Agilent N6705 DC power analyzer saves time**

- Provides unrivaled productivity gains for sourcing and measuring DC voltage and current into your DUT by integrating up to four advanced power supplies with DMM, scope, arb, and datalogger features.
- Eliminates the need to gather multiple pieces of equipment, create complex test setups including transducers (such as current probes and shunts) to measure current into your DUT.
- Eliminates the need to develop and debug programs to control a collection of instruments and take useful measurements because all the functions and measurements are available at the front panel.

### **Agilent N6705 DC power analyzer makes these tasks easy, right from the front panel**

- Setup and view critical turn-on/turn-off sequences
- Measure and display voltage, current versus time to visualize power into the DUT
- Control DC bias supply ramp-up/down rates
- Generate DC bias supply transients and disturbances
- Log data for seconds, minutes, hours, or even days to see current consumption or capture anomalies
- Save data and screen shots to internal storage or external USB memory devices
- Save and name your setup and tests for easy re-use
- Share setups with colleagues

### **New 14858A control and analysis software saves even more time**

The new 14858A Control and Analysis Software is a companion PC application that gives you control of up to four N6705 mainframes from a single PC control screen. With this software, you get improved data visualization and data management. Visit [www.agilent.com/find/14585](http://www.agilent.com/find/14585) for more information.

## Modular System Based on DC Power Supply Outputs

Feature	Benefit
Integrates capabilities of power supply, DMM, scope, arb and datalogger	Saves time by eliminating the need to find and interconnect multiple instruments.  Provides synergistic functions not available from separately connected instruments.
Large color graphics display	Fast simple quick set up and monitoring.  Ability to visualize results of multiple channels.
Connections and controls color-coded to the display	Fast set-up and control.  Confidence that you are configured and testing correctly.
Intuitive, dedicated physical controls for common functions	Fast set-up and control using a familiar interface, with each instrument function behaving like its standalone counterpart.
Access all capabilities without programming	Reduce 90% of the effort associated with set-up by eliminating the need for a PC, drivers, and software.



Figure 1. The Agilent N6705 DC power analyzer

The Agilent N6705 DC power analyzer is a modular system that is tailorable to meet specific test needs. At the heart of the DC power analyzer is the DC power module. The Agilent N6705 DC power analyzer is a mainframe that has four slots to accept one to four DC power modules. Each DC power module takes one slot, except for the N6754A 300 W high-performance autoranging DC power module, which occupies two slots. This modular design gives you the flexibility to mix and match over twenty different DC power modules to create a solution optimized to meet specific test requirements:

### The N6730, N6740, and N6770 Series of basic DC power modules

50 W, 100 W, and 300 W;  
up to 100 V, up to 20 A

### The N6750 Series of high-performance autoranging DC power modules

50 W, 100 W and 300 W; up to 60 V,  
up to 20 A

### The N6760 Series of precision DC power modules

50 W and 100 W; up to 50 V, up to 3 A

### The N6780 Series of precision DC power modules

20 W; up to 20 V, up to ± 3 A

## Voltmeter/Ammeter

R&D engineers can invest in high-performance outputs where speed and accuracy are needed, or purchase basic performance outputs for simple DC power requirements. In the future, as your test needs change, you can purchase different modules and swap them into the DC power analyzer, thus creating a solution that protects your investment and grows with you.

Each DC power module output is fully isolated and floating from ground and from each other.

Each DC power module in the Agilent N6705 DC power analyzer has a fully integrated voltmeter and ammeter to measure the actual voltage and current being sourced out of the DC output into the DUT. Because this voltmeter/ammeter function is built-in, it is easy to make measurements without additional wires or the added complexity of current sense resistors or current shunts. The accuracy of the voltage and current measurements are based on the type of module that is installed (basic, high-performance, precision). You can find the accuracy specification in the tables starting on page 14 under the performance parameter “Voltmeter/Ammeter Measurement Accuracy.”



**Figure 2.** DC power modules are easily installed into the N6705 DC power analyzer mainframe.

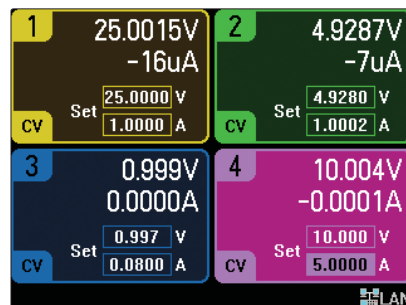

**Figure 3.** In Meter View, all 4 outputs can be viewed simultaneously. The both measured values for voltage and current and setting for voltage and current are displayed for each output.

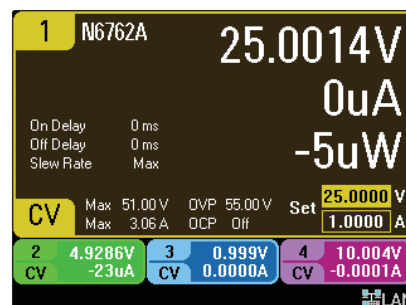
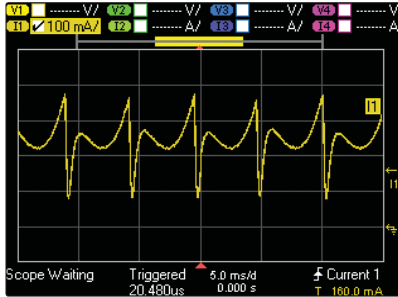

**Figure 4.** In Meter View, you can also view an enlarged view of one channel, displaying many settings and measured values, for that channel. A summary is shown for the other three channels.

## Oscilloscope

Each DC power module in the Agilent N6705 DC power analyzer has a fully integrated digitizer to capture the actual voltage versus time and current versus time being sourced out of the DC output into the DUT. This digitized data is displayed on the large color display just like an oscilloscope. Because this oscilloscope function is built-in, it is possible to make current measurements without current sense resistors, current shunts, or current probes. This greatly reduces measurement setup complexity and provides for accurate and fully specified, calibrated measurements. The accuracy of the measurements in oscilloscope mode is based on the type of module that is installed (basic, high-performance autoranging, precision, and SMU). You can find this information in the specifications tables starting on page 15 under the performance parameter "Oscilloscope Measurement Accuracy."

The N6760 Series of precision DC power modules offer simultaneous digitizing of output voltage and output current, such that you can view a voltage trace and a current trace at



**Figure 5.** In Scope View, voltage and current traces are displayed. In this picture, the DC current flowing into the DUT is clearly visible as a time-varying waveform.

the same time on the oscilloscope display. For all other module types, you can select to view either a voltage trace or a current trace on the oscilloscope display.

The digitizer in each module runs at up to 200 kHz and 512 k samples per trace. With an effective measurement bandwidth of up to 30 kHz, this oscilloscope function is perfectly matched to capture time varying events on the DC output, such as peak current demand, dropouts, rise times and other DC transients and disturbances.

The oscilloscope can be triggered on either voltage or current levels. Because the Agilent N6705 DC power analyzer is an integrated instrument, the oscilloscope can also be easily configured to trigger on the start of an arbitrary waveform or to trigger when the DC power output is enabled. For example, to make an inrush current measurement on your DUT, you can set the oscilloscope to trigger on the DC output's on/off key, set the trigger mode to single shot, and then turn on the DC output. This will immediately capture the current flowing out of the DC module into the DUT and give a picture of the inrush current of the DUT. This integrated functionality is not available when using a collection of separate test instruments on the test bench and is an example of how the DC power analyzer reduces setup time and complexity.

## Datalogger

The Agilent N6705 DC power analyzer can also function as a datalogger. Using the measurement capability built into each DC power module, the N6705 can continuously log data to the large color display and to a file. Data can be logged all four DC outputs at the same time. The accuracy of the logged voltage and current measurements are based on the type of module that is installed (basic, high-performance, precision, and SMU).

There are two modes of operation:

- In standard mode, measurements are made spaced apart by the sample period, which is programmable from 75 milliseconds to 60 seconds. For each DC output, the logged measurements can be voltage measurements, current measurements, or both. Each reading is an integrated voltage or current measurement. Standard mode datalogging is available on all DC module types.
- In continuously sampled mode, the built-in digitizer of the DC power module runs continuously at 50,000 readings per second. You can specify a sample period, which is the period of time during which these continuous readings will be accumulated. For each sample period, one average reading (and optionally, a minimum and maximum value) will be saved. In this mode, the digitizer runs continuously as the readings are averaged and stored; therefore, the digitizer is always making

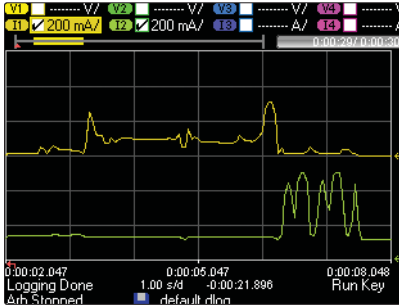

**Figure 6.** In Datalog View, you can log data on multiple traces. Here, the current flowing out of output 1 and output 2 are captured over 30 seconds

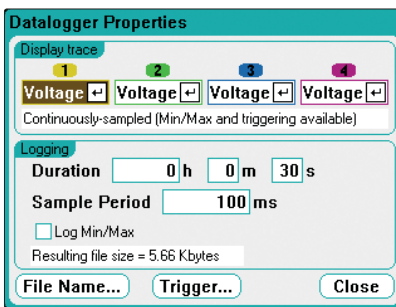

**Figure 7.** To set up the datalogger, you use a menu screen to select the operating parameters. Menu screens like this are used throughout the DC Power Analyzer for setup

measurements and no data is missed. The sample period is programmable from 1 millisecond to 60 seconds. In this mode, the N6760 Series of precision DC power modules offer simultaneous logging of output voltage and output current. For all other module types, you can select to log either voltage or a current when in continuous sampling mode.

The maximum datalog file size is 2 gigabytes, which is approximately 500 million readings. The logged data file can be stored on the N6705's internal non-volatile RAM or saved externally on a USB memory device.

The datalogger display can be saved as a GIF file for use in reports. The logged data can be saved for viewing at a later time. Logged data can also be exported to a CSV file that can be read by most common data analysis software packages.

# Arbitrary Waveform Generator

Each DC power output on the Agilent N6705 DC power analyzer can be modulated by the module's built-in arbitrary waveform generator function. This permits the DC output to act as a DC bias transient generator or power arbitrary waveform generator. The maximum bandwidth is based on the type of module that is installed (basic, high-performance, precision, and SMU). See page 21 for a table that lists the bandwidth for each DC power module type.

The Agilent N6705 uses run length encoding, where each point in the waveform is defined by the voltage setting and the dwell time or duration to stay at that setting. Waveforms can be generated by specifying only a small number of points. For example, a pulse would only take three points to define it.

The Agilent N6705 offers the following waveform choices:

Waveform	Number of points per waveform
Sine	100 points
Step	2 points
Ramp	100 points
Pulse	3 points
Stepped ramp (or staircase)	Determined by number of steps you program
Exponential	100 points
User defined voltage waveform (where the output is a voltage source)	Up to 512 points with point-by-point adjustable dwell
User defined current waveform (where the output is a current source)	Up to 64,000 points with programmable dwell (same for all points)

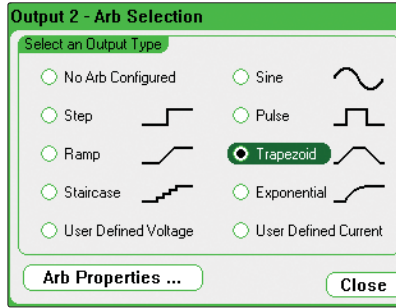

**Figure 8.** The Arb Selection menu is used to select which pre-programmed waveform will be applied to the output of the DC Power Module. Each of the four outputs can have a different waveform applied.

For each waveform, you can set it to repeat continuously or you can specify the number of times the waveform is repeated. For example, to generate a pulse train of 10 identical pulses, you can program the parameters for one pulse and then specify that you want it to repeat 10 times.

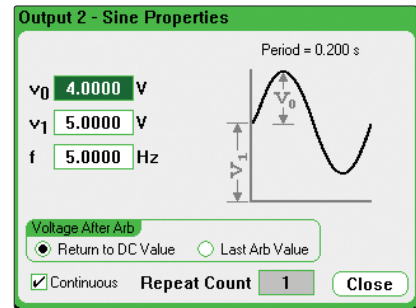

**Figure 9.** Once you've selected a waveform, you simply fill in the blanks to describe the waveform.

For the user defined voltage and current waveforms, you can download up to 512 set-points of voltage or current. For each set-point, a dwell time is specified and output will stay (i.e., dwell) at that set-point for the programmed dwell time value. For each of the 512 set-points in the user defined waveform, you can have a different dwell time from 0 to 262 seconds with 1 microsecond resolution. The module will step thru the user defined table of values, staying at each set-point for the programmed dwell time, and then it will move on to the next point. User defined waveforms can be imported from a CSV file or directly entered from the front panel of the DC power analyzer.

## Additional Features

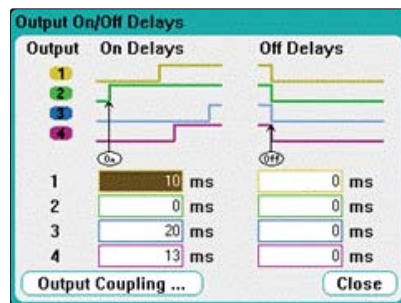

**Figure 10.** The Output On/Off Delays screen allows you to enter the delay times for each output. A graphical representation of the settings is shown to visually confirm your choices.

### Output sequencing

Each DC power module can be individually set to turn on or to turn off with a delay. By adjusting the delay times and then commanding the Agilent N6705 to turn on, you can set the Agilent N6705 modules to sequence on in a particular order. The same sequencing capability is available to shut down the modules in particular order. Delay times can be set from no delay to one thousand seconds of delay in one millisecond increments.

For applications that require more than four DC power modules to be sequenced, this output sequencing can be extended across multiple Agilent N6705 mainframes. By wiring together the I/O ports on the rear panel of the mainframes, a pair of synchronization signals is sent between mainframes, allowing the output sequences of each mainframe to be synchronized.

This capability is also supported to link Agilent N6705 output sequences with outputs installed in N6700B, N6701A and N6702A Low-Profile Modular Power System mainframes. It is not supported on N6700A mainframes.

### Programmable voltage slew

For some applications, like inrush limiting or powering rate-sensitive devices, it is necessary to slow down and control the speed of the DC output to maintain a specific voltage slew rate. The Agilent N6705 provides programmable voltage slew rate, so that you can easily control the speed at which the output slews from one voltage to another. You can set the speed of a voltage change anywhere from its maximum up/down programming speed to its slowest change of up to 10 seconds.

### Series and parallel operation

To increase available voltage and power per output, identically rated outputs can be operated directly in series. The maximum series operation is 240 V. To increase the available current and power per output, identically rated outputs can be operated directly in parallel. The maximum rated parallel operation is 100 A per Agilent N6705.

### Convenient front panel connections

The N6705 uses 3-way binding posts on the front panel for connection to the DUT. The binding posts accept standard banana plugs, bare wire, and spade-lug connectors. The binding posts are rated for 20 A per connection. To avoid setup and connection errors, the binding posts are color-coded to the control keys and the display. For modules with outputs rated at greater than 20 A, such as the N6753A, high current wires must be brought out through the N6705's rear panel.

### 4-wire sensing for improved measurement accuracy

To improve the voltage measurement accuracy and regulation of the DC outputs, the Agilent N6705 DC power analyzer offers 4-wire sensing capability, also called remote sensing, on each of the four outputs of the DC power analyzer. 4-wire remote sensing is useful when the DUT draws high current and you want to account for voltage drop in the power leads to achieve tight regulation and high voltage measurement accuracy. To use 4-wire sensing, in addition to your power leads, you connect two low current sensing leads between the DUT input terminals and 4-wire sense terminal binding posts located on the front of the N6705 power supply. This permits the output module to monitor and regulate its output voltage directly at the DUT input terminals instead of the N6705 front panel output binding posts. It then automatically adjusts its output voltage to compensate for voltage drops across the resistance in the power leads. For convenience,

switching between 2-wire mode (local sensing) and 4-wire mode (remote sensing) is done via an internal relay inside the N6705 DC power analyzer, eliminating the need for shorting bars or jumpers commonly found on other bench power sources.

#### **DC power modules offer low noise outputs**

Careful attention has been paid to this design to ensure low normal mode noise (ripple and peak-peak) as well as low common mode noise. While all DC power modules are switching power supplies, the N6750 high-performance autoranging DC power modules and the N6760 precision DC power modules are switching power supply designs that outperform most linear power supplies on the market.

#### **DC power modules provide fast voltage changes**

When it comes to speed, the N6750 high-performance autoranging DC power modules and the N6760 precision DC power modules achieve performance unlike a typical DC power supply. Thanks to an active down-programming circuit to rapidly pull down the output when lowering the module's output voltage, the N6750/60 can rapidly program both up and down in voltage. Changing voltage from 0 V to 50 V, or 50 V to 0 V, can be accomplished in less than 1.5 milliseconds. And for

smaller voltage changes, for example from 0 V to 5 V or 5 V to 0 V, the programming speed is less than 200 microseconds. These output speeds allow the N6750/60 to give maximum system throughput when your test calls for frequent changes in power supply voltage settings.

#### **Autoranging for flexibility**

The N6750 high-performance autoranging DC power modules and the N6760 precision DC power modules give you even more flexibility by providing autoranging outputs. This autoranging capability provides maximum output power at any output voltage up to 50 V. This allows one power supply to do the job of several power supplies because its operating range covers low voltage, high current as well as high voltage, low current operating points. For example, the N6751A high-performance, autoranging DC module,

rated at 50 V, 5 A, and 50 W can provide full power at 10 V @ 5 A (=50 W), 20 V @ 2.5 A (= 50 W), 33.3 V @ 1.5 A (= 50 W), 50 V @ 1 A (= 50 W) or anywhere in between. Therefore, this 50 W autoranging power supply, due to its extended voltage and current range, can produce voltage and current combinations in the range of a 250 W non-autoranging power supply. See page 27 for a diagram describing the details of the autoranging output characteristics of the N6750 and N6760 families of DC power modules.

#### **Use the N6760 DC power modules for precision low-level performance**

The N6760 precision DC power modules provide dual ranges on both programming and measurement. In the low range, these power supplies provide precision in the milliampere and microampere regions. They are

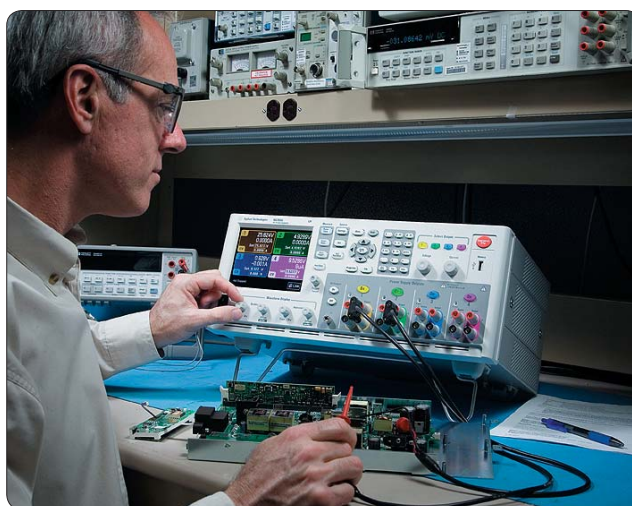

**Figure 11.** The Agilent N6705 DC power analyzer is a perfect size for the bench.

ideally suited for semiconductor and passive device testing, or where a precisely controlled output and highly accurate, precise measurements are needed during test. For even higher performance, the N6780 Series of SMU modules provides accuracies down to nanoamperes.

### Use the N6730/40/70 DC power modules for basic DC bias

Not all testing require high performance power supplies. When your budget is tight and when speed and accuracy are a low consideration, the N6730 Series of 50 W DC power modules, the N6740 Series of 100 W DC power modules, and the N6770 Series of 300 W DC power modules are an economical solution that give you clean, reliable DC power.

### Real time clock

The Agilent N6705 DC power analyzer has a built-in battery backed real time clock. This allows for proper time-stamping of logged data. It is also used to tag files with correct creation dates.



Figure 12. The N6705's front panel USB port

### Internal memory

The Agilent N6705 DC power analyzer has 1 gigabyte of non-volatile storage. This storage is shared between the four DC outputs. It can be used for saving test setups, test results, and screen images. External USB storage is supported for increased storage capacity to log data longer (see section "Front Panel USB").

### Front panel USB

The Agilent N6705 DC Power Analyzer provides a convenient front panel USB port designed exclusively for data storage devices, such as USB memory devices or USB hard drives. On devices connected to this USB port, you can save test setups, test results, and screen images. It is also an easy way to move test setup files between two N6705 DC Power Analyzers or test results between the DC Power Analyzer and a PC. You can also log data directly to the USB device plugged into the front panel. This extends the total storage capability of the N6705.

### Emergency stop

Should a hazardous situation occur during testing, you can press the large red Emergency Stop button on the front panel of the Agilent N6705. Pressing this easy-to-find button immediately removes power from the DC outputs. However, any data collection (such as a scope trace or data log) that is running at the time will continue to run. By doing so, the data you were collecting is saved and you will get a record of what was happening at the time of the event that caused you to press the Emergency Stop button. The measurements could aid in failure analysis, repair, or debugging of the DUT.



Figure 13. The Emergency Stop button shuts down all outputs immediately

### DUT protection features

Each Agilent N6705 DC power module is protected against over-voltage, over-current, and over-temperature. A fault condition in one module can be detected within 10 microseconds by other modules so that they can be quickly shut down to avoid hazardous conditions on your DUT.

### New Source/Measure Unit modules for the most demanding applications

The N6780 Series of source/measure units offer the highest level of performance in the N6700 Series. These SMUs feature highly accurate measurements down to nanoamperes while providing operation as a DC voltage source, DC current source, and electronic load. For details on these new products and how they can be used for applications including battery drain analysis and functional test, visit [www.agilent.com/find/N6780](http://www.agilent.com/find/N6780) and download the *N6780 Series Source/Measure Units (SMUs) for the N6700 Modular Power System Data Sheet*, literature number 5990-5829EN.

### **Output disconnect and polarity reversal relays**

Modules in the Agilent N6705 can be individually ordered with optional Output Disconnect Relays (option 761) or Output Disconnect/Polarity Reversal Relays (option 760). See table on page 29 for option 760 and 761 availability. All relays are built into the module, so no additional wiring is needed to get the relay function. With option 761, Output Disconnect Relays, an emergency condition or turning the DC output off causes mechanical relays disconnect both the plus and minus side of the power supply, including the sense leads. With option 760, Output Disconnect/Polarity Reversal Relays, mechanical relays switch the leads on both the plus and the minus side of the power supply, including the sense leads, resulting in a voltage polarity reversal at the DUT. In addition to polarity reversal, option 760 provides the same output disconnect function as option 761.

*Note: Output current is limited on some modules when option 760 Output Disconnect/Polarity Reversal Relays is installed. See the "Available options" tables at the bottom of page {29 and page 31} for more information about maximum current limitations with option 760.*

### **Triggering**

The Agilent N6705 DC power analyzer has hardware trigger in/trigger out signals which permit the Agilent N6705 to be synchronized with other test equipment. For example, when you turn on the outputs of the Agilent N6705, it can generate a trigger signal to start a measurement on an RF power meter.

### **Connectivity**

The Agilent N6705 DC power analyzer comes standard with GPIB, USB 2.0, and 10/100 base-T ethernet LAN interfaces. The Agilent N6705 is fully compliant with the LXI class C specification.

### **Security**

All non-volatile RAM data and settings can be cleared from the front panel. For customers who have security concerns about USB access to internally stored test data and setups, the Agilent N6705 also offers option AKY, which removes the USB ports from the front and rear of the Agilent N6705. When used in systems running GPIB, the LAN and/or USB interfaces can be disabled for extra security.

### **Control from any browser**

The Agilent N6705 can be controlled via a standard web browser. The Agilent N6705 contains a web server that provides a webpage containing a graphical front panel representation of the Agilent N6705 front panel. The WebGUI operation is identical to operating the real front panel on the Agilent N6705 DC power analyzer.

### **New 14585 Control & Analysis Software**

Control up to four N6705 main-frames. For more details visit [www.agilent.com/find/14585](http://www.agilent.com/find/14585)

### **Drivers**

For customers who wish to operate the DC Power Analyzer under computer control, the Agilent N6705 comes with both *VXIplug&play* drivers and IVI-COM drivers. LabView drivers are available at NI.COM.

### **Programming language**

The Agilent N6705 supports SCPI (Standard Commands for Programmable Instruments). Note that the Agilent N6705's command set is compatible with the N6700 modular power system for ATE, so programs written for the Agilent N6700 will work on the Agilent N6705.

### **Firmware updates**

The Agilent N6705 firmware is stored in FLASH ROM and can be easily updated when new features become available. Firmware can be downloaded into the Agilent N6705 over GPIB, LAN, or USB using the supplied firmware update utility program. Firmware updates can be found at [www.agilent.com/find/N6705firmware](http://www.agilent.com/find/N6705firmware).

**Makes a great tool for ATE systems that require an advanced user interface for test and debug**

While the Agilent N6705 DC power analyzer is designed primarily as an R&D bench tool, customers building ATE systems may find the Agilent N6705 has great utility in an ATE system. It is fully programmable, LXI class C certified, and takes the same commands as the Agilent N6700. But thanks to its large display and easy to use controls, test engineers may find the Agilent N6705 makes a great tool for visualizing test results as the tests execute, for DUT troubleshooting, for DUT debugging, and for ATE test development. The Agilent N6705 mounts in a standard 19" rack using standard rack mount hardware for 4 U instruments.

**Achieve correlation and share data between R&D and manufacturing**

The Agilent N6705 DC power analyzer is a modular system that uses the same DC power modules as the N6700 low-profile modular power system for ATE. Customers who use the N6705 in R&D and the N6700 in Manufacturing can easily achieve test correlation between R&D testing, design characterization/validation testing, and manufacturing testing because the DC power modules are common to both the bench and ATE versions of the product. Test programs can be easily shared between R&D and manufacturing since the Agilent N6705 and the Agilent N6700 share a common command set.

**Power management feature allows you to allocate N6705 mainframe power**

Often, a DUT requires some high power DC sources and several very low power DC sources. In this case, you may choose to configure a system where the sum of the power modules installed in the Agilent N6705 exceeds the total power available from the Agilent N6705 mainframe. The power management features of the Agilent N6705 allow you to allocate mainframe power to the outputs where it's needed, achieving maximum asset utilization and flexibility. This feature provides safety from unexpected and dangerous shutdowns that can occur with power systems without power management when operated in a similar way. For example, if your DUT requires

250 W on two of its inputs, but only 10 W each two auxiliary inputs, you can configure a system consisting of two 300 W DC modules and two 50 W DC modules. Even though the sum of the module power is greater than 600 W, you can still use the Agilent N6705. Thanks to the power management feature, you can allocate the 250 W each to the two 300 W modules while you allocate only 25 W to each of the 50 W modules.

**Universal AC input**

The Agilent N6705 has a universal input that operates from 100-240 VAC, 50/60/400 Hz. There are no switches to set or fuses to change when switching from one voltage standard to another. The AC input employs power factor correction.

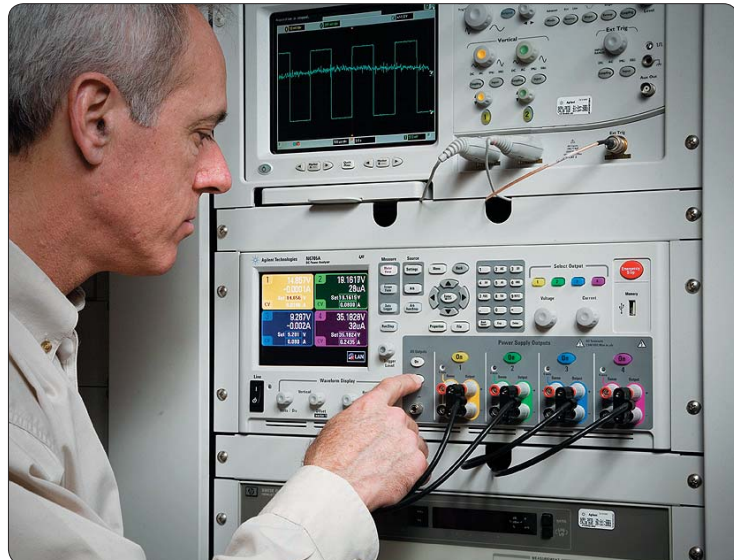

## Choosing the Right DC Power Modules to Meet Your Testing Needs

See detailed specifications on page 14



### **N6750 Series**

*For applications where the power supply plays a critical role*

The Agilent N6750 Series of high-performance, auto ranging DC power modules provides low noise, high accuracy and output voltage changes that are up to 10 to 50 times faster than other power supplies. In addition, auto ranging output capabilities enable one power supply to do the job of several traditional power supplies. The N6750 Series combines widest the arbitrary waveform generator bandwidth, available power up to 300 W, and high accuracy measurements. In oscilloscope mode, they can be configured to display either a voltage or a current trace. The N6753A is supported in the N6705B only.

### **N6780 Series**

*For applications where multi-quadrant operation and high-precision are required*

For details on these new products and how they can be used for applications including battery drain analysis and functional test, visit [www.agilent.com/find/N6780](http://www.agilent.com/find/N6780) and download the *N6780 Series Source/Measure Units (SMUs) for the N6700 Modular Power System Data Sheet*, literature number 5990-5829EN.

### **N6760 Series**

*For applications where precision is required*

The Agilent N6760 Series of precision DC power modules provides fast outputs changes (for wide arbitrary waveform generator bandwidth) and 16-bit voltage and current programming, and 18-bit measurements for precision in the milliamperere and microampere region. In oscilloscope mode, the N6760 Series offers the ability to view both a voltage and a current trace simultaneously.

### **N6730/40/70 Series**

*For basic DC applications*

The Agilent N6730, N6740 and N6770 families of DC power modules provide programmable voltage and current, measurement and protection features at a very economical price. These modules offer a wide range of voltage, current, and power outputs. In oscilloscope mode, they can be configured to display either a voltage or a current trace.

## Agilent N6751A/N6752A, N6754A and N6761A/N6762A Performance Specifications

Unless otherwise noted, specifications are warranted over the ambient temperature range of 0 to 55°C after a 30-minute warm-up period, with each module's sense terminals externally jumpered directly to their respective output terminals (local sensing).

Note: Performance specifications for the N6780 SMU modules can be found at [www.agilent.com/find/N6780](http://www.agilent.com/find/N6780). See the N6780 Series Source/Measure Units (SMUs) for the N6700 Modular Power System Data Sheet, literature number 5990-5829EN.

		<b>N6751A / N6752A</b>	<b>N6753A</b>	<b>N6754A</b>	<b>N6761A / N6762A</b>
<b>DC output ratings</b>					
	Voltage	50 V	20 V	60 V	50 V
	Current (derated 1% per °C above 40°C)	5 A / 10 A	50 A	20 A	1.5 A / 3 A
	Power	50 W / 100 W	300 W	300 W	50 W / 100 W
<b>Output ripple and noise (PARD)</b> (from 20 Hz – 20 MHz)					
	CV peak-to-peak	4.5 mV	5 mV	6 mV	4.5 mV
	CV rms	350 µV	1 mV	1 mV	350 µV
<b>Load effect (Regulation)</b> (for any output load change, with a maximum load-lead drop of 1 V per lead)					
	Voltage	2 mV	2 mV	2 mV	0.5 mV
	Current (@ 0 - 7 V)	2 mA	12 mA	5 mA	30 µA
	(@ 0 - 50 V)	2 mA	12 mA	5 mA	65 µA
<b>Source effect (Regulation)</b>					
	Voltage	1 mV	0.5 mV	1.2 mV	0.5 mV
	Current	1 mA	5 mA	2 mA	30 µA
<b>Programming accuracy</b> (at 23°C ±5°C after 30 minute warm-up. Applies from min. to max. programming range)					
	Voltage high range	0.06% + 19 mV	0.06% + 10 mV	0.06% + 25 mV	0.016% + 6 mV
	Voltage low range (≤ 5.5 V)	N/A	N/A	N/A	0.016% + 1.5 mV
	Current high range	0.1% + 20 mA	0.10% + 30 mA	0.10% + 8 mA	0.04% + 200 µA
	Current low range (≤ 100 mA, @ 0 - 7 V)	N/A	N/A	N/A	0.04% + 15 µA
	(≤ 100 mA, @ 0 - 50 V)	N/A	N/A	N/A	0.04% + 55 µA
<b>Measurement accuracy</b> (at 23°C ±5°C)					
	Voltage high range	0.05% + 20 mV	0.05% + 10 mV	0.05% + 25 mV	0.016% + 6 mV
	Voltage low range (≤ 5.5 V)	N/A	N/A	N/A	0.016% + 1.5 mV
	Current high range	0.1% + 4 mA	0.10% + 30 mA	0.10% + 8 mA	0.04% + 160 µA
	Current low range (≤ 100 mA, @ 0 - 7 V) <sup>NOTE 1</sup>	N/A	N/A	N/A	0.03% + 15 µA <sup>NOTE 2</sup>
	(≤ 100 mA, @ 0 - 50 V)	N/A	N/A	N/A	0.03% + 55 µA
<b>Load transient recovery time</b> (time to recover to within the settling band following a load change)					
• from 60% to 100% and from 100% to 60% of full load for models N6751A & N6761A					
• from 50% to 100% and from 100% to 50% of full load for models N6752A-N6754A & N6762A.					
	Voltage settling band	± 75 mV <sup>NOTE 2</sup>	± 30 mV	± 90 mV <sup>NOTE 3</sup>	± 75 mV
	Time	< 100 µs	< 100 µs	< 100 µs	< 100 µs

<sup>1</sup> Applies when measuring 4096 data points (SENSe:SWEp:POINTS = 4096).

<sup>2</sup> Settling band is ±125 mV for Model N6752A when relay option 761 is installed.

<sup>3</sup> Settling band is ±350 mV for Model N6754A when relay option 760 or 761 is installed.

## Agilent N6751A/N6752A, N6754A and N6761A/N6762A Supplemental Characteristics

Supplemental characteristics are not warranted but are descriptions of performance determined either by design or type testing.  
All supplemental characteristics are typical unless otherwise noted.

		<b>N6751A / N6752A</b>	<b>N6753A</b>	<b>N6754A</b>	<b>N6761A / N6762A</b>
<b>Programming ranges</b>					
	Voltage high range	20 mV – 51 V	10 mV – 24.48 V	25 mV – 61.2 V	15 mV – 51 V
	Voltage low range ( $\leq 5.5$ V)	N/A	N/A	N/A	12 mV – 5.5 V
	Current high range	10 mA – 5.1 A/ 10 mA – 10.2 A	50 mA – 51 A	20 mA – 20.4 A	1 mA – 1.53 A/ 1 mA – 3.06 A
	Current low range ( $\leq 0.1$ A)	N/A	N/A	N/A	0.1 mA – 0.1 A <sup>NOTE 1</sup>
<b>Programming resolution</b>					
	Voltage high range	3.5 mV <sup>NOTE 2</sup>	1.5 mV <sup>NOTE 2</sup>	4.2 mV <sup>NOTE 2</sup>	880 $\mu$ V <sup>NOTE 3</sup>
	Voltage low range ( $\leq 5.5$ V)	N/A	N/A	N/A	90 $\mu$ V
	Current high range	3.25 mA <sup>NOTE 4</sup>	16.3 mA <sup>NOTE 4</sup>	6.5 mA <sup>NOTE 4</sup>	60 $\mu$ A
	Current low range ( $\leq 0.1$ A)	N/A	N/A	N/A	2 $\mu$ A
<b>Measurement resolution</b>					
	Voltage high range	1.8 mV <sup>NOTE 5</sup>	0.8 mV <sup>NOTE 5</sup>	2.2 mV <sup>NOTE 5</sup>	440 $\mu$ V <sup>NOTE 6</sup>
	Voltage low range ( $\leq 5.5$ V)	N/A	N/A	N/A	44 $\mu$ V
	Current high range	410 $\mu$ A	2.05 mA	820 $\mu$ A	30 $\mu$ A
	Current low range ( $\leq 0.1$ A)	N/A	N/A	N/A	1 $\mu$ A
<b>Programming temperature coefficient per °C</b>					
	Voltage high range	18 ppm + 160 $\mu$ V	20 ppm + 20 $\mu$ V	20 ppm + 50 $\mu$ V	18 ppm + 140 $\mu$ V
	Voltage low range ( $\leq 5.5$ V)	N/A	N/A	N/A	40 ppm + 70 $\mu$ V
	Current high range	100 ppm + 45 $\mu$ A	60 ppm + 500 $\mu$ A	60 ppm + 200 $\mu$ A	33 ppm + 10 $\mu$ A
	Current low range ( $\leq 0.1$ A)	N/A	N/A	N/A	60 ppm + 1.5 $\mu$ A
<b>Measurement temperature coefficient per °C</b>					
	Voltage high range	25 ppm + 35 $\mu$ V	20 ppm + 20 $\mu$ V	20 ppm + 50 $\mu$ V	23 ppm + 40 $\mu$ V
	Voltage low range ( $\leq 5.5$ V)	N/A	N/A	N/A	30 ppm + 40 $\mu$ V
	Current high range	60 ppm + 3 $\mu$ A	60 ppm + 30 $\mu$ A	60 ppm + 12 $\mu$ A	40 ppm + 0.3 $\mu$ A
	Current low range ( $\leq 0.1$ A)	N/A	N/A	N/A	50 ppm + 0.3 $\mu$ A
<b>Output ripple and noise (PARD)</b>					
	CC rms	2 mA	10 mA	4 mA	2 mA
<b>Common mode noise</b> (from 20 Hz – 20 MHz; from either output to chassis)					
	rms	500 $\mu$ A	500 $\mu$ A	750 $\mu$ A	500 $\mu$ A
	peak-to-peak	< 2 mA	2 mA	3 mA	< 2 mA
<b>Over-voltage protection</b>					
	Accuracy	0.25% + 250 mV	0.25% $\pm$ 150 mV	0.25% $\pm$ 300 mV	0.25% + 250 mV
	Maximum setting	55 V	22 V	66 V	55 V
	Response time	50 $\mu$ s from occurrence of over-voltage condition to start of output shutdown			

<sup>1</sup> If you are operating the unit below 255  $\mu$ A in constant current mode, the output may become unregulated with the following load conditions:

The load resistance is <175 m $\Omega$  and the load inductance is >20  $\mu$ H. If this occurs, an UNRegulated flag will be generated and the output current may rise above the programmed value but will remain less than 255  $\mu$ A.

<sup>2</sup> Based on 14-bit DAC, with DAC range adjusted by software calibration

<sup>3</sup> Based on 16-bit DAC, with DAC range adjusted by software calibration

<sup>4</sup> Based on 12-bit DAC, with DAC range adjusted by software calibration

<sup>5</sup> Based on 16-bit ADC (15 bits plus sign), with ADC range adjusted by software calibration

<sup>6</sup> Based on 18-bit ADC (17 bits plus sign), with ADC range adjusted by software calibration

## Agilent N6751A/N6752A, N6754A and N6761A/N6762A Supplemental Characteristics

(Continued)

		N6751A / N6752A	N6753A <sup>NOTE 4</sup>	N6754A N6762A	N6761A / N6762A
<b>Maximum up-programming time with full resistive load</b>					
(time from 10% to 90% of total voltage excursion)	For voltage change of up-programming time	0 to 10 V 0.2 ms	0 to 6 V 0.3 ms	0 to 15 V 0.35 ms	0 to 10 V 0.6 ms
	For voltage change of up-programming time	0 to 50 V 1.5 ms	0 to 20 V 1.5 ms	0 to 60 V 2.0 ms	0 to 50 V 2.2 ms
<b>Maximum up-programming settling time with full resistive load</b>					
(time from start of voltage change to within 50 mV of final value)	For voltage change of up-programming settling time	0 to 10 V 0.5 ms	0 to 6 V 2.0 ms	0 to 15 V 0.8 ms	0 to 10 V 0.9 ms
	For voltage change of up-programming settling time	0 to 50 V 4.0 ms	0 to 20 V 3.0 ms	0 to 60 V 4.2 ms	0 to 50 V 4.0 ms
<b>Maximum down-programming time with no load</b>					
(time from start of voltage change to output voltage < 0.5 V)	For voltage change of down-programming time	10 to 0 V 0.3 ms	6 to 0 V 0.5 ms	15 to 0 V 0.6 ms	10 to 0 V 0.3 ms
	For voltage change of down-programming time	50 to 0 V 1.3 ms	20 to 0 V 1.6 ms	60 to 0 V 2.2 ms	50 to 0 V 1.3 ms
<b>Maximum down-programming settling time with no load</b>					
(time from start of voltage change to output voltage within 50 mV of final value)	For voltage change of down-programming settling time	10 to 0 V 0.45 ms	6 to 0 V 0.7 ms	15 to 0.8 V 0.8 ms	10 to 0 V 0.45 ms
	For voltage change of down-programming settling time	50 to 0 V 1.4 ms	20 to 0 V 3.0 ms	60 to 0 V 2.3 ms	50 to 0 V 1.4 ms
<b>Down-programming time with capacitive load <sup>NOTE 1</sup></b>					
(time from start of voltage change to output voltage < 0.5 V)	Capacitive load	1000 $\mu$ F <sup>NOTE 1</sup>	4700 $\mu$ F <sup>NOTE 2</sup>	680 $\mu$ F <sup>NOTE 3</sup>	1000 $\mu$ F <sup>NOTE 1</sup>
	For voltage change of down-programming time	10 to 0 V 0.3 ms	6 to 0 V 0.5 ms	15 to 0 V 2.3 ms	10 to 0 V 0.3 ms
	For voltage change of down-programming time	50 to 0 V 1.3 ms	20 to 0 V 1.6 ms	60 to 0 V 10.0 ms	50 to 0 V 1.3 ms
<b>Down-programming capability</b>					
	Continuous power	7 W	12.5 W	12.5 W	7 W
	Peak current	7 A	15 A	6 A	3.8 A
<b>Remote sense capability</b>					
Outputs can maintain specifications with up to a 1-volt drop per load lead.					
<b>Series and parallel operation</b>					
Identically rated outputs can be operated directly in parallel or can be connected for straight series operation. Auto-series and auto-parallel operation is not available.					

<sup>1</sup> Modules can discharge a 1000  $\mu$ F capacitor from 50 V to 0 V at a rate of 4 times/second.

<sup>2</sup> Modules can discharge a 4700  $\mu$ F capacitor from 20 V to 0 V at a rate of 4 times/second.

<sup>3</sup> Modules can discharge a 680  $\mu$ F capacitor from 60 V to 0 V at a rate of 4 times/second.

<sup>4</sup> N6753A is supported in the N6705B only. It requires special installation instructions that ship with the module.

# Agilent N6731B – N6736B and N6741B – N6746B Performance Specifications

Unless otherwise noted, specifications are warranted over the ambient temperature range of 0 to 55°C after a 30-minute warm-up period, with each module's sense terminals externally jumpered directly to their respective output terminals (local sensing)

		<b>N6731B/ N6741B</b>	<b>N6732B/ N6742B</b>	<b>N6733B/ N6743B</b>	<b>N6734B/ N6744B</b>	<b>N6735B/ N6745B</b>	<b>N6736B/ N6746B</b>
<b>DC output ratings:</b>							
	Voltage	5 V	8 V	20 V	35 V	60 V	100 V
	Current <sup>NOTE 1</sup>	10 A / 20 A	6.25 A / 12.5 A <sup>NOTE 3</sup>	2.5 A / 5 A	1.5 A / 3 A	0.8 A / 1.6 A	0.5 A / 1 A
	Power	50 W / 100 W	50 W / 100 W	50 W / 100 W	52.5 W / 105 W	50 W / 100 W	50 W / 100 W
<b>Output ripple and noise (PARD)</b> (from 20 Hz – 20 MHz)							
	CV peak-to-peak	10 mV / 11 mV	12 mV	14 mV	15 mV	25 mV	30 mV
	CV rms	2 mV	2 mV	3 mV	5 mV	9 mV	18 mV
<b>Load effect (Regulation)</b> (with output change from no load to full load, up to a maximum load-lead drop of 1 V/lead)							
	Voltage	5 mV	6 mV	9 mV	11 mV	13 mV / 16 mV	20 mV / 30 mV
	Current	2 mA	2 mA	2 mA	2 mA	2 mA	2 mA
<b>Source effect (Regulation)</b>							
	Voltage	1 mV	2 mV	2 mV	4 mV	6 mV	10 mV
	Current	1 mA	1 mA	1 mA	1 mA	1 mA	1 mA
<b>Programming accuracy</b> (@ 23 °C ±5°C after 30 minute warm-up. Applies from minimum to maximum programming range)							
	Voltage	0.1% + 19 mV	0.1% + 19 mV	0.1% + 20 mV	0.1% + 35 mV	0.1% + 60 mV	0.1% + 100 mV
	Current	0.15% + 20 mA	0.15% + 20 mA	0.15% + 20 mA	0.15% + 20 mA	0.15% + 20 mA	0.15% + 10 mA
<b>Voltmeter/ammeter measurement accuracy</b> (at 23°C ±5°C)							
	Voltage	0.1% + 20 mV	0.1% + 20 mV	0.1% + 20 mV	0.1% + 35 mV	0.1% + 60 mV	0.1% + 100 mV
	Current	0.15% + 20 mA	0.15% + 10 mA	0.15% + 5 mA	0.15% + 4 mA	0.15% + 4 mA	0.15% + 2 mA
<b>Load transient recovery time</b> (time to recover to within the settling band following a load change from 50% to 100% and from 100% to 50% of full load.)							
	Voltage settling band	±0.08 V / 0.1 V <sup>NOTE 2</sup>	±0.08 V / 0.1 V <sup>NOTE 2</sup>	±0.2 V / 0.3 V	±0.2 V / 0.3 V	±0.4 V / 0.5 V	±0.5 V / 1.0 V
	Time	< 200 μs	< 200 μs	< 200 μs	< 200 μs	< 200 μs	< 200 μs

<sup>1</sup> Output current is derated 1% per °C above 40°C.

<sup>2</sup> Settling band is ±0.10 V/0.125 V for 5 V and 8 V Models when relay options 760 and 761 are installed.

<sup>3</sup> For N6742B, output current is limited to 10 A when option 760 Output Disconnect/Polarity Reversal Relays is installed.

## Agilent N6731B – N6736B and N6741B – N6746B Supplemental Characteristics

Supplemental characteristics are not warranted but are descriptions of performance determined either by design or type testing.  
All supplemental characteristics are typical unless otherwise noted.

		<b>N6731B/ N6741B</b>	<b>N6732B/ N6742B</b>	<b>N6733B/ N6743B</b>	<b>N6734B/ N6744B</b>	<b>N6735B/ N6745B</b>	<b>N6736B/ N6746B</b>	
<b>Programming ranges</b>								
	Voltage	15 mV – 5.1 V	15 mV – 8.16 V	30 mV – 20.4 V	40 mV – 35.7 V	70 mV – 61.2 V	100 mV – 102 V	
	Current	60 mA – 10.2 A/ 60 mA – 20.4 A	40 mA – 6.375 A/ 40 mA – 12.75 A	10 mA – 2.55 A/ 10 mA – 5.1 A	5 mA – 1.53 A/ 5 mA – 3.06 A	2.5 mA – 0.85 A/ 2.5 mA – 1.7 A	1.5 mA – 0.51 A/ 1.5 mA – 1.02 A	
<b>Programming resolution</b> <small>NOTE 1</small>								
	Voltage	3.5 mV	4 mV	7 mV	10 mV	18 mV	28 mV	
	Current	7 mA	4 mA	3 mA	2 mA	1 mA	0.5 mA	
<b>Measurement resolution</b> <small>NOTE 2</small>								
	Voltage	3 mV	4 mV	10 mV	18 mV	30 mV	50 mV	
	Current	10 mA	7 mA	3 mA	2 mA	1 mA	0.5 mA	
<b>Programming temperature coefficient per °C</b>								
	Voltage	0.005% + 0.1 mV	0.005% + 0.1 mV	0.005% + 0.2 mV	0.005% + 0.5 mV	0.005% + 0.5 mV	0.005% + 1 mV	
	Current	0.005% + 1 mA	0.005% + 0.5 mA	0.005% + 0.1 mA	0.005% + 0.05 mA	0.005% + 0.02 mA	0.005% + 0.02 mA	
<b>Measurement temperature coefficient per °C</b>								
	Voltage	0.01% + 0.1 mV	0.01% + 0.1 mV	0.01% + 0.2 mV	0.01% + 0.2 mV	0.01% + 0.5 mV	0.01% + 0.5 mV	
	Current	0.01% + 1 mA	0.01% + 0.5 mA	0.01% + 0.1 mA	0.01% + 0.05 mA	0.01% + 0.02 mA	0.01% + 0.02 mA	
<b>Output ripple and noise (PARD)</b>								
	CC rms	8 mA	4 mA	2 mA	2 mA	2 mA	2 mA	
<b>Common mode noise</b> (from 20 Hz – 20 MHz; from either output to chassis)								
	rms	1 mA	1 mA	1 mA	1 mA	1 mA	1 mA	
	peak-to-peak	< 15 mA	< 10 mA	< 10 mA	< 10 mA	< 10 mA	< 10 mA	
<b>Over-voltage protection</b>								
	Accuracy	0.25% + 50 mV	0.25% + 50 mV	0.25% + 75 mV	0.25% + 100 mV	0.25% + 200 mV	0.25% + 250 mV	
	Accuracy w/opt 760	0.25% + 600 mV	0.25% + 600 mV	0.25% + 350 mV	0.25% + 250 mV	0.25% + 300 mV	0.25% + 300 mV	
	Accuracy w/opt 761	0.25% + 600 mV	0.25% + 600 mV	0.25% + 350 mV	0.25% + 250 mV	0.25% + 300 mV	0.25% + 300 mV	
	Maximum setting	7.5 V	10 V	22 V	38.5 V	66 V	110 V	
	Response time	50 µs from occurrence of over-voltage condition to start of output shutdown						
<b>Maximum up-programming and down-programming time with full resistive load</b> (time from 10% to 90% of total voltage excursion)								
	Voltage setting from 0 V to full scale and full scale to 0 V	20 ms	20 ms	20 ms	20 ms	20 ms	20 ms	
<b>Maximum up-programming and down-programming settling time with full resistive load</b> (time from start of voltage change until voltage settles within 0.1% of the full-scale voltage of its final value)								
	Voltage setting from 0 V to full scale and full scale to 0 V	100 ms	100 ms	100 ms	100 ms	100 ms	100 ms	
<b>Remote sense capability</b> Outputs can maintain specifications with up to a 1-volt drop per load lead.								
<b>Series and parallel operation</b> Identically rated outputs can be operated directly in parallel or can be connected for straight series operation. Auto-series and auto-parallel operation is not available.								
<b>Oscilloscope measurement accuracy</b> (at 23°C ±5°C, Accuracy of any individual point in the trace)								
	Voltage	0.1% + 25 mV	0.1% + 30 mV	0.1% + 45 mV	0.1% + 75 mV	0.1% + 130 mV	0.1% + 190 mV	
	Current with current compensation on <small>NOTE 3</small>	0.15% + 7 mA	0.15% + 70 mA	0.15% + 40 mA	0.15% + 20 mA	0.15% + 14 mA	0.15% + 12 mA	0.15%
	Current with current compensation off <small>NOTE 4</small>	0.15% + 50 mA	0.15% + 30 mA	0.15% + 15 mA	0.15% + 10 mA	0.15% + 9 mA	0.15% + 5 mA	

<sup>1</sup> Based on 12-bit DAC, with DAC range adjusted by software calibration

<sup>2</sup> Based on 12-bit ADC (11 bits plus sign), with ADC range adjusted by software calibration

<sup>3</sup> Current compensation on means the selection labeled "Compensate current measurements during voltage transients" is checked on the Meter Properties screen

<sup>4</sup> Current compensation off means the selection labeled "Compensate current measurements during voltage transients" is not checked on the Meter Properties screen

## Agilent N6773A – N6776A Performance Specifications

Unless otherwise noted, specifications are warranted over the ambient temperature range of 0 to 55°C after a 30-minute warm-up period, with each module's sense terminals externally jumpered directly to their respective output terminals (local sensing).

		N6773A	N6774A	N6775A	N6776A
<b>DC output ratings</b>					
	Voltage	20 V	35 V	60 V	100 V
	Current <sup>NOTE 1</sup>	15 A <sup>NOTE 3</sup>	8.5 A	5 A	3 A
	Power	300 W	300 W	300 W	300 W
<b>Output ripple and noise (PARD)</b> (from 20 Hz – 20 MHz)					
	CV peak-to-peak	20 mV	22 mV	35 mV	45 mV
	CV rms	3 mV	5 mV	9 mV	18 mV
<b>Load effect (Regulation)</b> (with output change from no load to full load, up to a maximum load-lead drop of 1 V/lead)					
	Voltage	13 mV	16 mV	24 mV	45 mV
	Current	6 mA	6 mA	6 mA	6 mA
<b>Source effect (Regulation)</b>					
	Voltage	2 mV	4 mV	6 mV	10 mV
	Current	1 mA	1 mA	1 mA	1 mA
<b>Programming accuracy:</b> (@ 23°C ±5°C after 30 minute warm-up. Applies from minimum to maximum programming range)					
	Voltage	0.1% + 20 mV	0.1% + 35 mV	0.1% + 60 mV	0.1% + 100 mV
	Current	0.15% + 60 mA	0.15% + 60 mA	0.15% + 60 mA	0.15% + 30 mA
<b>Voltmeter/ammeter measurement accuracy</b> (at 23°C ±5°C)					
	Voltage	0.1% + 20 mV	0.1% + 35 mV	0.1% + 60 mV	0.1% + 100 mV
	Current	0.15% + 15 mA	0.15% + 12 mA	0.15% + 12 mA	0.15% + 6 mA
<b>Load transient recovery time</b> (time to recover to within the settling band following a load change from 50% to 100% and from 100% to 50% of full load.)					
	Voltage settling band	± 0.3 V <sup>NOTE 2</sup>	± 0.3 V <sup>NOTE 2</sup>	± 0.5 V	± 1.0 V
	Time	< 250 μs	< 250 μs	< 250 μs	< 250 μs

<sup>1</sup> Output current is derated 1% per °C above 40°C.

<sup>2</sup> Settling band is ±0.35 V for 20 V and 35 V Models when relay options 760 and 761 are installed.

<sup>3</sup> For N6773A, output current is limited to 10 A when option 760 Output Disconnect/Polarity Reversal Relays is installed.

## Agilent N6773A – N6776A Supplemental Characteristics

Supplemental characteristics are not warranted but are descriptions of performance determined either by design or type testing.  
All supplemental characteristics are typical unless otherwise noted

		N6773A	N6774A	N6775A	N6776A
<b>Programming ranges</b>					
	Voltage	30 mV – 20.4 V	40 mV – 35.7 V	70 mV – 61.2 V	100 mV – 102 V
	Current	30 mA – 15.3 A	15 mA – 8.67 A	7.5 mA – 5.1 A	4.5 mA – 3.06 A
<b>Programming resolution</b> <sup>NOTE 1</sup>					
	Voltage	7 mV	10 mV	18 mV	28 mV
	Current	9 mA	6 mA	3 mA	1.5 mA
<b>Measurement resolution</b> <sup>NOTE 2</sup>					
	Voltage	10 mV	18 mV	30 mV	50 mV
	Current	9 mA	6 mA	3 mA	1.5 mA
<b>Programming temperature coefficient per °C</b>					
	Voltage	0.01% + 0.2 mV	0.01% + 0.5 mV	0.01% + 0.5 mV	0.01% + 1 mV
	Current	0.01% + 0.5 mA	0.01% + 0.5 mA	0.01% + 0.1 mA	0.01% + 0.1 mA
<b>Measurement temperature coefficient per °C</b>					
	Voltage	0.01% + 0.2 mV	0.01% + 0.2 mV	0.01% + 0.5 mV	0.01% + 0.5 mV
	Current	0.01% + 0.5 mA	0.01% + 0.5 mA	0.01% + 0.05 mA	0.01% + 0.05 mA
<b>Output ripple and noise (PARD)</b>					
	CC rms	6 mA	6 mA	6 mA	6 mA
<b>Common mode noise</b> (from 20 Hz – 20 MHz; from either output to chassis)					
	Rms	2 mA	2 mA	2 mA	2 mA
	Peak-to-peak	< 20 mA	< 20 mA	< 20 mA	< 20 mA
<b>Over-voltage protection</b>					
	Accuracy	0.25% + 100 mV	0.25% + 130 mV	0.25% + 260 mV	0.25% + 650 mV
	Accuracy w/opt 760	0.25% + 700 mV	0.25% + 700 mV	0.25% + 400 mV	0.25% + 650 mV
	Accuracy w/opt 761	0.25% + 500 mV	0.25% + 350 mV	0.25% + 350 mV	0.25% + 650 mV
	Maximum setting	22 V	38.5 V	66 V	110 V
	Response time	50 µs from occurrence of over-voltage condition to start of output shutdown			
<b>Maximum up-programming and down-programming time with full resistive load</b> (time from 10% to 90% of total voltage excursion)					
	Voltage setting from 0 V to full scale and full scale to 0 V	20 ms	20 ms	20 ms	20 ms
<b>Maximum up-programming and down-programming settling time with full resistive load</b> (time from start of voltage change until voltage settles within 0.1% of the full-scale voltage of its final value)					
	Voltage setting from 0 V to full scale and full scale to 0 V	100 ms	100 ms	100 ms	100 ms
<b>Remote sense capability</b>					
	Outputs can maintain specifications with up to a 1-volt drop per load lead.				
<b>Series and parallel operation</b>					
	Identically rated outputs can be operated directly in parallel or can be connected for straight series operation. Auto-series and auto-parallel operation is not available.				
<b>Oscilloscope measurement accuracy</b> (@ 23°C ±5°C, Accuracy of any individual point in the trace)					
	Voltage	0.1% + 45 mV	0.1% + 75 mV	0.1% + 120 mV	0.1% + 160 mV
	Current with current compensation on <sup>NOTE 3</sup>	0.15% + 45 mA	0.15% + 27 mA	0.15% + 22 mA	0.15% + 12 mA
	Current with current compensation off <sup>NOTE 4</sup>	0.15% + 35 mA	0.15% + 22 mA	0.15% + 19 mA	0.15% + 9 mA

<sup>1</sup> Based on 12-bit DAC, with DAC range adjusted by software calibration

<sup>2</sup> Based on 12-bit ADC (11 bits plus sign), with ADC range adjusted by software calibration

<sup>3</sup> Current compensation on means the selection labeled “Compensate current measurements during voltage transients” is checked on the Meter Properties screen

<sup>4</sup> Current compensation off means the selection labeled “Compensate current measurements during voltage transients” is not checked on the Meter Properties screen

## Agilent N6705 DC Power Analyzer Supplemental Characteristics

Supplemental characteristics are not warranted but are descriptions of performance determined either by design or by type testing. All supplemental characteristics are typical unless otherwise noted.

### Arbitrary waveform generator maximum bandwidth

Maximum bandwidth is based on a sine wave into a resistive load and applies to any output current level. In the tables below, THD means Total Harmonic Distortion, V<sub>p-p</sub> means volts peak-to-peak, 3 dB max frequency is the frequency where the output voltage drops to 3 dB below the programmed value, and 6 dB max frequency is the frequency where the output voltage drops to 6 dB below the programmed value.

### N6780 Series 2-quadrant source/measure units

SMU maximum bandwidth is > 10 kHz. Contact Agilent Technologies for more information about SMU bandwidth.

### N6750 High-performance autoranging DC power modules and N6760 precision DC power modules

N6751 N6752	3 dB max frequency	THD at 3 dB max frequency	Frequency below which THD is less than 1.5%
0.5 V <sub>p-p</sub>	4000 Hz	12.0%	440 Hz
1 V <sub>p-p</sub>	2200 Hz	21.0%	440 Hz
2.5 V <sub>p-p</sub>	900 Hz	25.0%	265 Hz
5 V <sub>p-p</sub>	500 Hz	27.0%	160 Hz
50 V <sub>p-p</sub>	340 Hz	22.0%	25 Hz

N6754	3 dB max frequency	THD at 3 dB max frequency	Frequency below which THD is less than 1.5%
0.6 V <sub>p-p</sub>	3600 Hz	6.0%	2100 Hz
1.2 V <sub>p-p</sub>	2600 Hz	10.0%	1280 Hz
3 V <sub>p-p</sub>	1700 Hz	17.0%	800 Hz
6 V <sub>p-p</sub>	1000 Hz	17.0%	480 Hz
60 V <sub>p-p</sub>	340 Hz	22.0%	30 Hz

N6761 N6762	3 dB max Frequency	THD at 3 dB max frequency	Frequency below which THD is less than 1.5%
0.5 V <sub>p-p</sub>	4500 Hz	14.0%	450 Hz
1 V <sub>p-p</sub>	3600 Hz	14.0%	450 Hz
2.5 V <sub>p-p</sub>	1300 Hz	25.0%	340 Hz
5 V <sub>p-p</sub>	600 Hz	25.0%	250 Hz
50 V <sub>p-p</sub>	350 Hz	22.0%	30 Hz

## Agilent N6705 DC Power Analyzer Supplemental Characteristics (Continued)

Supplemental characteristics are not warranted but are descriptions of performance determined either by design or by type testing. All supplemental characteristics are typical unless otherwise noted.

### Arbitrary waveform generator maximum bandwidth

Maximum bandwidth is based on a sine wave into a resistive load and applies to any output current level. In the tables below, THD means Total Harmonic Distortion, V<sub>p-p</sub> means volts peak-to-peak, 3 dB max frequency is the frequency where the output voltage drops to 3 dB below the programmed value, and 6 dB max frequency is the frequency where the output voltage drops to 6 dB below the programmed value.

### N6730 50 W and N6740 100 W basic DC power modules

<b>N6731B N6741B</b>	3 dB max frequency	THD at 3 dB max frequency	6 dB max frequency	THD at 6 dB max frequency
0.05 V <sub>p-p</sub>	175 Hz	1.0%	260 Hz	3.0%
0.1 V <sub>p-p</sub>	125 Hz	1.0%	175 Hz	3.0%
0.25 V <sub>p-p</sub>	75 Hz	6.0%	100 Hz	6.0%
0.5 V <sub>p-p</sub>	40 Hz	9.0%	55 Hz	9.0%
5 V <sub>p-p</sub>	20 Hz	10.0%	37 Hz	10.0%

<b>N6732B N6742B</b>	3 dB max frequency	THD at 3 dB max frequency	6 dB max frequency	THD at 6 dB max frequency
0.08 V <sub>p-p</sub>	125 Hz	1.0%	200 Hz	3.0%
0.16 V <sub>p-p</sub>	125 Hz	1.0%	180 Hz	3.0%
0.4 V <sub>p-p</sub>	75 Hz	6.0%	100 Hz	6.0%
0.8 V <sub>p-p</sub>	40 Hz	8.5%	60 Hz	8.5%
8 V <sub>p-p</sub>	20 Hz	10.0%	37 Hz	10.0%

<b>N6733B N6743B</b>	3 dB max frequency	THD at 3 dB max frequency	6 dB max frequency	THD at 6 dB max frequency
0.2 V <sub>p-p</sub>	110 Hz	1.0%	190 Hz	3.0%
0.4 V <sub>p-p</sub>	110 Hz	1.0%	160 Hz	3.0%
1 V <sub>p-p</sub>	72 Hz	6.0%	95 Hz	6.0%
2 V <sub>p-p</sub>	40 Hz	8.0%	55 Hz	8.5%
20 V <sub>p-p</sub>	20 Hz	10.0%	37 Hz	10.0%

## Agilent N6705 DC Power Analyzer Supplemental Characteristics (Continued)

Supplemental characteristics are not warranted but are descriptions of performance determined either by design or by type testing. All supplemental characteristics are typical unless otherwise noted.

### Arbitrary waveform generator maximum bandwidth

Maximum bandwidth is based on a sine wave into a resistive load and applies to any output current level. In the tables below, THD means Total Harmonic Distortion, V<sub>p-p</sub> means volts peak-to-peak, 3 dB max frequency is the frequency where the output voltage drops to 3 dB below the programmed value, and 6 dB max frequency is the frequency where the output voltage drops to 6 dB below the programmed value.

### N6730 50 W and N6740 100 W basic DC power modules (Continued)

<b>N6734B N6744B</b>	3 dB max frequency	THD at 3 dB max frequency	6 dB max frequency	THD at 6 dB max frequency
0.35 V <sub>p-p</sub>	125 Hz	1.0%	200 Hz	1.0%
0.7 V <sub>p-p</sub>	125 Hz	1.0%	175 Hz	3.5%
1.75 V <sub>p-p</sub>	72 Hz	6.0%	100 Hz	6.0%
3.5 V <sub>p-p</sub>	40 Hz	8.0%	55 Hz	8.5%
35 V <sub>p-p</sub>	20 Hz	8.0%	37 Hz	8.5%

<b>N6735B N6745B</b>	3 dB max frequency	THD at 3 dB max frequency	6 dB max frequency	THD at 6 dB max frequency
0.6 V <sub>p-p</sub>	100 Hz	1.0%	180 Hz	1.0%
1.2 V <sub>p-p</sub>	100 Hz	1.0%	160 Hz	3.0%
3 V <sub>p-p</sub>	70 Hz	5.5%	92 Hz	5.5%
6 V <sub>p-p</sub>	40 Hz	8.0%	55 Hz	8.0%
60 V <sub>p-p</sub>	20 Hz	8.0%	37 Hz	8.0%

<b>N6736B N6746B</b>	3 dB max frequency	THD at 3 dB max frequency	6 dB max frequency	THD at 6 dB max frequency
1 V <sub>p-p</sub>	90 Hz	1.0%	160 Hz	1.5%
2 V <sub>p-p</sub>	90 Hz	1.0%	150 Hz	3.0%
5 V <sub>p-p</sub>	62 Hz	4.5%	85 Hz	6.0%
10 V <sub>p-p</sub>	37 Hz	8.0%	50 Hz	8.0%
100 V <sub>p-p</sub>	20 Hz	8.0%	35 Hz	8.0%

## Agilent N6705 DC Power Analyzer Supplemental Characteristics (Continued)

Supplemental characteristics are not warranted but are descriptions of performance determined either by design or by type testing. All supplemental characteristics are typical unless otherwise noted.

### Arbitrary waveform generator maximum bandwidth

Maximum bandwidth is based on a sine wave into a resistive load and applies to any output current level. In the tables below, THD means Total Harmonic Distortion, V<sub>p-p</sub> means volts peak-to-peak, 3 dB max frequency is the frequency where the output voltage drops to 3 dB below the programmed value, and 6 dB max frequency is the frequency where the output voltage drops to 6 dB below the programmed value.

### N6770 300 W basic DC power modules

<b>N6773A</b>	3 dB max frequency	THD at 3 dB max frequency	6 dB max frequency	THD at 6 dB max frequency
0.2 V <sub>p-p</sub>	125 Hz	1.5%	210 Hz	4.0%
0.4 V <sub>p-p</sub>	125 Hz	1.5%	180 Hz	4.0%
1 V <sub>p-p</sub>	75 Hz	6.0%	95 Hz	6.0%
2 V <sub>p-p</sub>	42 Hz	9.0%	60 Hz	9.0%
20 V <sub>p-p</sub>	20 Hz	10.0%	37 Hz	10.0%

<b>N6774A</b>	3 dB max frequency	THD at 3 dB max frequency	6 dB max frequency	THD at 6 dB max frequency
0.35 V <sub>p-p</sub>	125 Hz	1.0%	200 Hz	1.0%
0.7 V <sub>p-p</sub>	125 Hz	1.0%	160 Hz	3.0%
1.75 V <sub>p-p</sub>	75 Hz	6.0%	95 Hz	6.0%
3.5 V <sub>p-p</sub>	40 Hz	8.5%	55 Hz	8.5%
35 V <sub>p-p</sub>	20 Hz	10.0%	37 Hz	10.0%

<b>N6775A</b>	3 dB max frequency	THD at 3 dB max frequency	6 dB max frequency	THD at 6 dB max frequency
0.6 V <sub>p-p</sub>	120 Hz	1.0%	200 Hz	1.0%
1.2 V <sub>p-p</sub>	120 Hz	1.0%	160 Hz	3.0%
3 V <sub>p-p</sub>	70 Hz	5.0%	95 Hz	6.0%
6 V <sub>p-p</sub>	40 Hz	8.5%	55 Hz	8.5%
60 V <sub>p-p</sub>	20 Hz	10.0%	35 Hz	10.0%

<b>N6776A</b>	3 dB max frequency	THD at 3 dB max frequency	6 dB max frequency	THD at 6 dB max frequency
1 V <sub>p-p</sub>	75 Hz	1.0%	160 Hz	1.0%
2 V <sub>p-p</sub>	75 Hz	1.0%	150 Hz	3.0%
5 V <sub>p-p</sub>	55 Hz	4.0%	75 Hz	6.0%
10 V <sub>p-p</sub>	35 Hz	8.0%	45 Hz	8.0%
100 V <sub>p-p</sub>	N/A	N/A	35 Hz	8.0%

## Agilent N6705A and N6705B DC Power Analyzer Mainframes

### N6705A, N6705B

<b>Maximum total output power</b> (= Sum of total module output power)	N6705A, N6705B	600 W	when operating from 100 – 240 VAC input
<b>Command processing time</b>	From receipt of command to start of the output change	≤ 1 ms	
<b>Protection response characteristics</b>	INH input	5 μs from receipt of inhibit to start of shutdown	
	Fault on coupled outputs	< 10 μs (from receipt of fault to start of shutdown)	
<b>Digital control characteristics</b>	Maximum voltage ratings	16.5 VDC/- 5 VDC between pins (pin 8 is internally connected to chassis ground).	
	Pins 1 and 2 as FLT output	Maximum low-level output voltage = 0.5 V @ 4 mA Maximum low-level sink current = 4 mA Typical high-level leakage current = 0.14 mA @ 16.5 VDC	
	Pins 1 - 7 as digital/trigger outputs (pin 8 = common)	Maximum low-level output voltage = 0.5 V @ 4 mA; 1 V @ 50 mA; 1.75 V @ 100 mA Maximum low-level sink current = 100 mA Typical high-level leakage current = 0.12 mA @ 16.5 VDC	
	Pins 1 - 7 as digital/trigger inputs and pin 3 as INH input (pin 8 = common)	Maximum low-level input voltage = 0.8 V Minimum high-level input voltage = 2 V Typical low-level current = 2 mA @ 0 V (internal 2.2 k pull-up) Typical high-level leakage current = 0.12 mA @ 16.5 VDC	
	Trig out BNC	Maximum low-level output voltage = 0.8 V @ 1.25 mA Minimum high-level output voltage = 4.0 V @ 1.25 mA Typical output pulse width = 8 μs	
	Trig in BNC (with internal 100 Kohm pull-up)	Maximum low-level input voltage = 1.3 V Minimum high-level input voltage = 2.7 V Minimum input pulse width = 2 μs	
<b>Interface capabilities</b>	GPIB:	SCPI - 1993, IEEE 488.2 compliant interface	
	LXI compliance	Class C	
	USB 2.0	Requires Agilent IO Library version M.01.01 and up, or 14.0 and up	
	10/100 LAN	Requires Agilent IO Library version L.01.01 and up, or 14.0 and up	
	Built-in web server	Requires Internet Explorer 5+ or Netscape 6.2+	
<b>Environmental conditions</b>	Operating environment	Indoor use, installation category II (for AC input), pollution degree 2	
	Temperature range	0°C to 55°C (current is derated 1% per °C above 40°C ambient temperature)	
	Relative humidity	Up to 95%	
	Altitude	Up to 2000 meters	
	Storage temperature	-30°C to 70°C	
	LED statement	Any LEDs used in this product are Class 1 LEDs as per IEC 825-1	

## Agilent N6705A and N6705B DC Power Analyzer Mainframes (Continued)

### N6705A, N6705B

<b>Regulatory compliance</b>	EMC	<p>Complies with the European EMC directive for Class A test and measurement products.</p> <p>Complies with the Australian standard and carries the C-Tick mark.</p> <p>This ISM device complies with Canadian ICES-001.</p> <p>Cet appareil ISM est conforme à la norme NMB-001 du Canada.</p> <p><b>Electrostatic discharges greater than 1 kV near the I/O connectors may cause the unit to reset and require operator intervention.</b></p>
	Safety	<p>Complies with the European Low Voltage Directive and carries the CE-marking.</p> <p>This product also complies with the US and Canadian safety standards for test and measurement products.</p>
<b>Acoustic noise declaration</b>	<p>This statement is provided to comply with the requirements of the German Sound Emission Directive, from 18 January 1991.</p>	<p>Sound pressure <math>L_p &lt; 70</math> dB(A),                      At operator position and normal operation, according to EN 27779 (Type Test).                      Schalldruckpegel <math>L_p &lt; 70</math> dB(A)                      Am arbeitsplatz und normaler betrieb, nach EN 27779 (Typprüfung).</p>
<b>Output terminal isolation</b>	Maximum rating	No output terminal may be more than 240 VDC from any other terminal or chassis ground.
<b>AC input</b>	Nominal input ratings	100 VAC – 240 VAC; 50/60 Hz/400 Hz
	Input range	86 VAC – 264 VAC
	Power consumption	1500 VA typical
	Fuse	Internal fuse (not customer accessible)
<b>Weight</b>	N6705 with 4 installed modules	Net: 17.3 kg; 38 lbs.
	Single-wide power module	Net: 1.23 kg; 2.71 lbs
	Double-wide power module	Net: 2.18 kg; 4.8 lbs

# Autoranging Characteristic

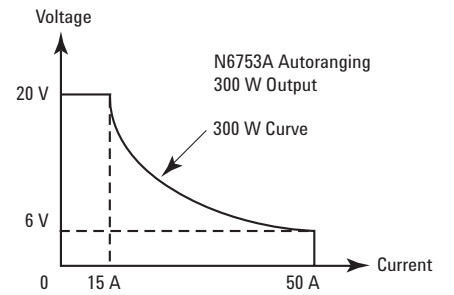
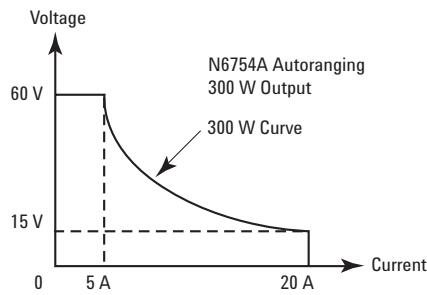
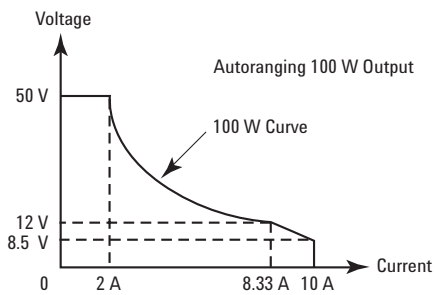
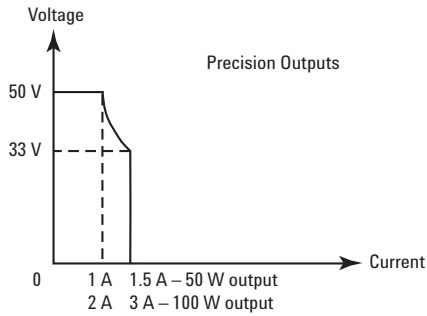
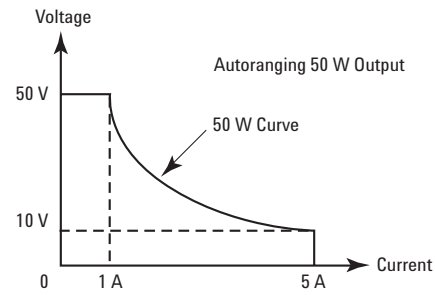

# Outline Diagram

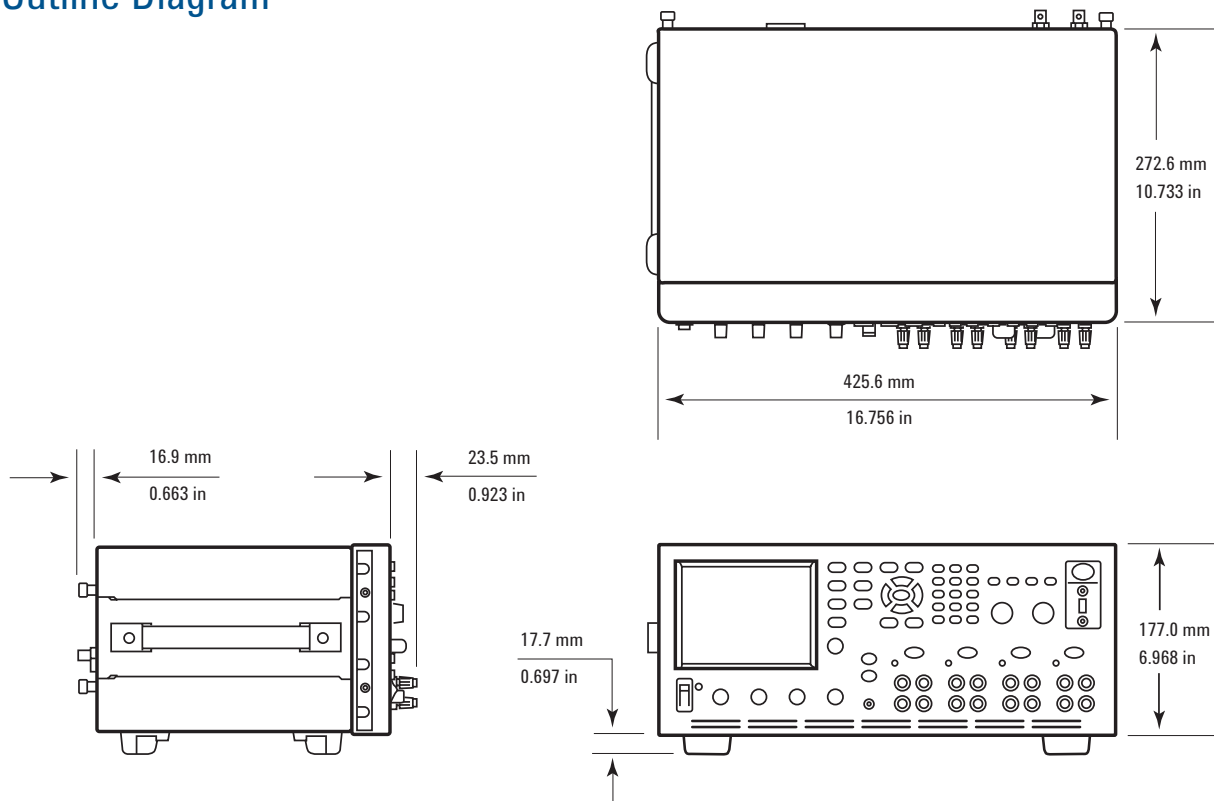

## Ordering Information

### The DC power analyzer system is available 2 ways:

- (1) You can order an N6705B mainframe and various modules as separate products. (See steps below.) Each item will arrive in a separate box such that you can assemble the analyzer yourself when you need to.
- (2) You can order an N6715B system, which is a build-to-order DC power analyzer system that is shipped as a fully assembled multiple-output power supply. (See pages 30 and 31 for N6715B ordering information.)

When ordering the DC power analyzer as a mainframe and modules, follow these steps:

#### Step 1:

Select the appropriate documentation and line cord options.

#### Step 2:

Order 1 to 4 modules (see next page). If the sum of the power of the modules exceeds the available output power rating on the mainframe, see page 12 for an explanation of Agilent's power management capability. Note that each mainframe has 4 module slots to hold modules. Each module occupies one module slot, except for the N6754A, which occupies 2 module slots per module.

### Mainframe

<b>N6705B</b>	DC power analyzer mainframe Holds 1 to 4 modules. Total available output power = 600 W.
---------------	---

### Available options to the N6705B mainframe

<b>908</b>	Rack mount kit
<b>AKY</b>	Delete front/rear USB This option removes all USB capability from the DC power analyzer. Both the front panel USB port and the rear panel USB port are removed.
<b>055</b>	Delete Datalogger This option disables the Datalogger functionality in the DC power analyzer firmware. The DC power analyzer hardware is unchanged. To enable the Datalogger functionality at a later time, order the N6705U upgrade kit.
<b>ABA</b>	Full documentation on CD-ROM and printed Users Guide
<b>0B0</b>	Full documentation on CD-ROM only; no printed documentation package
<b>900</b>	Power Cord, United Kingdom, P/N 8120-1351
<b>901</b>	Power Cord, Australia, New Zealand, P/N 8120-1369
<b>902</b>	Power Cord, Europe, Korea, P/N 8120-1689
<b>903</b>	Power Cord, USA, Canada, 120 V, P/N 8120-4383
<b>904</b>	Power Cord, USA, Canada, 240 V, P/N 8120-0698
<b>906</b>	Power Cord, Switzerland, P/N 8120-2104
<b>912</b>	Power Cord, Denmark, P/N 8120-2956
<b>917</b>	Power Cord, South Africa, India, P/N 8120-4211
<b>918</b>	Power Cord, Japan, 100 V, P/N 8120-5342
<b>919</b>	Power Cord, Israel, P/N 8120-6800
<b>920</b>	Power Cord, Argentina, P/N 8120-6869
<b>921</b>	Power Cord, Chile, P/N 8120-6980
<b>922</b>	Power Cord, China, P/N 8120-8376
<b>927</b>	Power Cord, Thailand, Brazil, P/N 8120-8871

## Ordering Information

### Modules

Order 1 to 4 modules to be installed in each N6705 DC power analyzer mainframe. (To order modules as part of the N6715 build-to-order systems, see page 31). If the sum of the power of the modules exceeds the available output power rating on the mainframe, see page 12 for an explanation of Agilent's power management capability.

You can individually specify each option for each module. For example, you can order one module with Option 761 Output Disconnect Relays while the remaining modules have no relay option.

As your needs change and you want to change configuration or add more modules to the existing N6705 mainframe, use this ordering information to order the required modules.

### Modules

<b>N6730 50 W DC power modules</b>	<b>N6731B</b>	5 V, 10 A, 50 W DC Power Module
	<b>N6732B</b>	8 V, 6.25 A, 50 W DC Power Module
	<b>N6733B</b>	20 V, 2.5 A, 50 W DC Power Module
	<b>N6734B</b>	35 V, 1.5 A, 50 W DC Power Module
	<b>N6735B</b>	60 V, 0.8 A, 50 W DC Power Module
	<b>N6736B</b>	100 V, 0.5 A, 50 W DC Power Module
<b>N6740 100 W DC power modules</b>	<b>N6741B</b>	5 V, 20 A, 100 W DC Power Module
	<b>N6742B</b>	8 V, 12.5 A, 100 W DC Power Module
	<b>N6743B</b>	20 V, 5 A, 100 W DC Power Module
	<b>N6744B</b>	35 V, 3 A, 100 W DC Power Module
	<b>N6745B</b>	60 V, 1.6 A, 100 W DC Power Module
	<b>N6746B</b>	100 V, 1 A, 100 W DC Power Module
<b>N6750 High-performance, autoranging DC power modules</b>	<b>N6751A</b>	50 V, 5 A, 50 W High-Performance Autoranging DC Power Module
	<b>N6752A</b>	50 V, 10 A, 100 W High-Performance Autoranging DC Power Module
	<b>N6753A</b>	20 V, 50 A, 300 W High-Performance Autoranging DC Power Module (occupies 2 module slots in the mainframe)
	<b>N6754A</b>	60 V, 20 A, 300 W High-Performance Autoranging DC Power Module (occupies 2 module slots in the mainframe)
<b>N6760 precision DC power modules</b>	<b>N6761A</b>	50 V, 1.5 A, 50 W Precision DC Power Module
	<b>N6762A</b>	50 V, 3 A, 100 W Precision DC Power Module
<b>N6770 300 W DC power modules</b>	<b>N6773A</b>	20 V, 15 A, 300 W DC Power Module
	<b>N6774A</b>	35 V, 8.5 A, 300 W DC Power Module
	<b>N6775A</b>	60 V, 5 A, 300 W DC Power Module
	<b>N6776A</b>	100 V, 3 A, 300 W DC Power Module
	<b>N6780 Series 2-quadrant SMUs</b>	<b>N6781A</b>
	<b>N6782A</b>	20 V, ± 3 A, 20 W 2-Quadrant DC Power Module for Functional Test

### Available options to DC power modules

	<b>N6731B-N6736B 50 W DC power modules</b>	<b>N6741B-N6746B 100 W DC power modules</b>	<b>N6751A-N6752A high-performance autoranging DC power modules</b>	<b>N6754A 300 W high-performance autoranging DC power module</b>	<b>N6761A-N6762A precision DC power modules</b>	<b>N6773A-N6776A 300 W DC power modules</b>	<b>N6781A-N6782A SMUs</b>
<b>Output disconnect relays</b>	761	761	761	761	761	761	Standard
<b>Output disconnect and polarity reversal relays</b>	760	760 (see note 1, 2)	Not available	760	Not available	760 (see note 2)	Not available
<b>Large size FPGA Installed</b>	Not available, not required	Not available, not required	LGA (Required, see note 3)	Not available, not required	Not available, not required	Not available, not required	Not available, not required
<b>Commercial calibration with test results data</b>	UK6	UK6	UK6	UK6	UK6	UK6	UK6
<b>ISO 17025 Cal certificate</b>	1A7	1A7	1A7	1A7	1A7	1A7	Not available

<sup>1</sup> Option 760 is not available on N6741B.

<sup>2</sup> When Option 760 is installed in N6742B or N6773A, the maximum output current is limited to 10 A.

<sup>3</sup> You must order Option LGA on N6751A and N6752A modules.

<sup>4</sup> High Speed Test Extensions (HSTE) is not needed on modules for use in the DC power analyzer.

## Ordering Information

### N6715B build-to-order systems

To purchase a DC power analyzer system, order a N6715B. This model number is a build-to-order system that is shipped as a fully tested and assembled instrument. Each system consists of one mainframe plus optionally 1 to 4 modules. Each mainframe has 4 module slots to hold modules. Each module occupies one module slot, except for the N6754A, which occupies 2 module slots per module. To specify which modules you want installed in the system, the modules are ordered as options to the system model number. You must order at least 1 module.

If the sum of the power of the modules exceeds the available output power rating on the mainframe, see page 12 for an explanation of Agilent's power management capability.

If you prefer to purchase a DC power analyzer mainframe and modules as separate pieces, see page 28.

### Build-to-order system

<b>N6715B System</b>	Build-to-order DC power analyzer system Consists of 1 N6705 mainframe with total available power of 600 W.
----------------------	---

### Available options to the N6715B System

<b>908</b>	Rack mount kit
<b>AKY</b>	Delete front/rear USB This option removes all USB capability from the DC power analyzer. Both the front panel USB port and the rear panel USB port are removed.
<b>055</b>	Delete Datalogger This option disables the Datalogger functionality in the DC power analyzer firmware. The DC power analyzer hardware is unchanged. To enable the Datalogger functionality at a later time, order the N6705U upgrade kit.
<b>ABA</b>	Full documentation on CD-ROM and printed Users Guide
<b>0B0</b>	Full documentation on CD-ROM only; no printed documentation package
<b>900</b>	Power Cord, United Kingdom, P/N 8120-1351
<b>901</b>	Power Cord, Australia, New Zealand, P/N 8120-1369
<b>902</b>	Power Cord, Europe, Korea, P/N 8120-1689
<b>903</b>	Power Cord, USA, Canada, 120 V, P/N 8120-4383
<b>904</b>	Power Cord, USA, Canada, 240 V, P/N 8120-0698
<b>906</b>	Power Cord, Switzerland, P/N 8120-2104
<b>912</b>	Power Cord, Denmark, P/N 8120-2956
<b>917</b>	Power Cord, South Africa, India, P/N 8120-4211
<b>918</b>	Power Cord, Japan, 100 V, P/N 8120-5342
<b>919</b>	Power Cord, Israel, P/N 8120-6800
<b>920</b>	Power Cord, Argentina, P/N 8120-6869
<b>921</b>	Power Cord, Chile, P/N 8120-6980
<b>922</b>	Power Cord, China, P/N 8120-8376
<b>927</b>	Power Cord, Thailand, Brazil, P/N 8120-8871

## Ordering Information

### Modules as options to N6715B

To order 1 to 4 modules as options to an N6715B, specify its model number, followed by “-ATO.” For example, to order an N6731B as an option to the N6715B, you would specify “N6731B-ATO” as the option. (To order modules as separate products, see page 29.) If the sum of the power of the modules exceeds the available output power rating on the mainframe, see page 12 for an explanation of Agilent’s power management capability.

You can individually specify each option for each module. For example, you can order one module with Option 761 Output Disconnect Relays while the remaining modules have no relay option.

### Module options for N6710B, N6711A and N6712A systems

<b>N6730 50 W DC power modules</b>	<b>N6731B-ATO</b>	5 V, 10 A, 50 W DC Power Module
	<b>N6732B-ATO</b>	8 V, 6.25 A, 50 W DC Power Module
	<b>N6733B-ATO</b>	20 V, 2.5 A, 50 W DC Power Module
	<b>N6734B-ATO</b>	35 V, 1.5 A, 50 W DC Power Module
	<b>N6735B-ATO</b>	60 V, 0.8 A, 50 W DC Power Module
	<b>N6736B-ATO</b>	100 V, 0.5 A, 50 W DC Power Module
<b>N6740 100 W DC power modules</b>	<b>N6741B-ATO</b>	5 V, 20 A, 100 W DC Power Module
	<b>N6742B-ATO</b>	8 V, 12.5 A, 100 W DC Power Module
	<b>N6743B-ATO</b>	20 V, 5 A, 100 W DC Power Module
	<b>N6744B-ATO</b>	35 V, 3 A, 100 W DC Power Module
	<b>N6745B-ATO</b>	60 V, 1.6 A, 100 W DC Power Module
	<b>N6746B-ATO</b>	100 V, 1 A, 100 W DC Power Module
<b>N6750 High-performance autoranging DC power Modules</b>	<b>N6751A-ATO</b>	50 V, 5 A, 50 W High-Performance Autoranging DC Power Module
	<b>N6752A-ATO</b>	50 V, 10 A, 100 W High-Performance Autoranging DC Power Module
	<b>N6753A-ATO</b>	20 V, 50 A, 300 W High-Performance Autoranging DC Power Module (occupies 2 module slots in the mainframe)
	<b>N6754A-ATO</b>	60 V, 20 A, 300 W High-Performance Autoranging DC Power Module (occupies 2 module slots in the mainframe)
<b>N6760 Precision DC power modules</b>	<b>N6761A-ATO</b>	50 V, 1.5 A, 50 W Precision DC Power Module
	<b>N6762A-ATO</b>	50 V, 3 A, 100 W Precision DC Power Module
<b>N6770 300 W DC power modules</b>	<b>N6773A-ATO</b>	20 V, 15 A, 300 W DC Power Module
	<b>N6774A-ATO</b>	35 V, 8.5 A, 300 W DC Power Module
	<b>N6775A-ATO</b>	60 V, 5 A, 300 W DC Power Module
	<b>N6776A-ATO</b>	100 V, 3 A, 300 W DC Power Module
<b>N6780 Series 2-quadrant SMUs</b>	<b>N6781A-ATO</b>	20 V, $\pm 3$ A, 20 W 2-Quadrant DC Power Module for Battery Drain Analysis
	<b>N6782A-ATO</b>	20 V, $\pm 3$ A, 20 W 2-Quadrant DC Power Module for Functional Test

### Available options to N6700 modules

	<b>N6731B-ATO to N6736B-ATO 50 W DC power modules</b>	<b>N6741B-ATO to N6746B-ATO 100 W DC power modules</b>	<b>N6751A-ATO to N6752A-ATO High-performance autoranging DC power modules</b>	<b>N6753A-ATO to N6754A-ATO 300 W High-performance autoranging DC power modules</b>	<b>N6761A-ATO to N6762A-ATO precision DC power modules</b>	<b>N6773A-ATO to N6776A-ATO 300 W DC power modules</b>	<b>N6781A-ATO N6782A-ATO SMUs</b>
<b>Output disconnect relays</b>	761	761	761	761	761	761	Standard
<b>Output disconnect and polarity reversal relays</b>	760	760 (see note 1, 2)	Not available	760	Not available	760 (see note 2)	Not available
<b>High speed test extensions (HSTE)</b>	Not available	Not available	054	054	Standard	Not available	Standard
<b>Large size FPGA installed</b>	Not available, not required	Not available, not required	LGA (Required, see note 3)	Not available, not required	Not available, not required	Not available, not required	Not available, not required
<b>Commercial calibration with test results data</b>	UK6	UK6	UK6	UK6	UK6	UK6	UK6
<b>ISO 17025 Cal certificate</b>	1A7	1A7	1A7	1A7	1A7	1A7	Not available

<sup>1</sup> Option 760 is not available on N6741B-ATO.

<sup>2</sup> When Option 760 is installed in N6742B-ATO or N6773A-ATO, the maximum output current is limited to 10 A.

<sup>3</sup> You must order Option LGA on N6751A and N6752A modules. Option LGA adds a large size FGPA to the module. Option LGA is required to support the Output Sequencing between multiple mainframes. Option LGA will also allow for future expansion for additional firmware features.



### Agilent Email Updates

[www.agilent.com/find/emailupdates](http://www.agilent.com/find/emailupdates)  
Get the latest information on the products and applications you select.

### Agilent Channel Partners

[www.agilent.com/find/channelpartners](http://www.agilent.com/find/channelpartners)  
Get the best of both worlds: Agilent's measurement expertise and product breadth, combined with channel partner convenience.



### [www.lxistandard.org](http://www.lxistandard.org)

LXI is the LAN-based successor to GPIB, providing faster, more efficient connectivity. Agilent is a founding member of the LXI consortium.

## Remove all doubt

Our repair and calibration services will get your equipment back to you, performing like new, when promised. You will get full value out of your Agilent equipment throughout its lifetime. Your equipment will be serviced by Agilent-trained technicians using the latest factory calibration procedures, automated repair diagnostics and genuine parts. You will always have the utmost confidence in your measurements. For information regarding self maintenance of this product, please contact your Agilent office.

Agilent offers a wide range of additional expert test and measurement services for your equipment, including initial start-up assistance, onsite education and training, as well as design, system integration, and project management.

For more information on repair and calibration services, go to:

[www.agilent.com/find/removealldoubt](http://www.agilent.com/find/removealldoubt)

### [www.agilent.com](http://www.agilent.com)

[www.agilent.com/find/N6700](http://www.agilent.com/find/N6700)

For more information on Agilent Technologies' products, applications or services, please contact your local Agilent office. The complete list is available at:

[www.agilent.com/find/contactus](http://www.agilent.com/find/contactus)

#### Americas

Canada	(877) 894 4414
Latin America	305 269 7500
United States	(800) 829 4444

#### Asia Pacific

Australia	1 800 629 485
China	800 810 0189
Hong Kong	800 938 693
India	1 800 112 929
Japan	0120 (421) 345
Korea	080 769 0800
Malaysia	1 800 888 848
Singapore	1 800 375 8100
Taiwan	0800 047 866
Thailand	1 800 226 008

#### Europe & Middle East

Austria	43 (0) 1 360 277 1571
Belgium	32 (0) 2 404 93 40
Denmark	45 70 13 15 15
Finland	358 (0) 10 855 2100
France	0825 010 700*

\*0.125 €/minute

Germany	49 (0) 7031 464 6333
Ireland	1890 924 204
Israel	972-3-9288-504/544
Italy	39 02 92 60 8484
Netherlands	31 (0) 20 547 2111
Spain	34 (91) 631 3300
Sweden	0200-88 22 55
Switzerland	0800 80 53 53
United Kingdom	44 (0) 118 9276201

Other European Countries:

[www.agilent.com/find/contactus](http://www.agilent.com/find/contactus)

Revised: October 1, 2009

Product specifications and descriptions in this document subject to change without notice.

© Agilent Technologies, Inc. 2007, 2010  
Printed in USA, July 8, 2010  
5989-6319EN

### Need a power solution for ATE?

The new Agilent N6700 Modular Power Analyzer is small, flexible, and fast

- Ideal for ATE systems in R&D, design validation, and manufacturing
- Small size: up to 4 outputs in 1U of rack space
- Flexible, modular system: Can mix and match power levels and performance levels to optimize investment
- Uses same modules as N6705 DC Power Analyzers
- Fast command processing times to improve throughput
- Connect via GPIB, LAN, or USB
- Fully compliant to LXI Class C specification



Complete specifications can be found in the *N6700 Modular Power System Data Sheet*, publication 5958-1411EN. For more information, go to [www.agilent.com/find/N6700](http://www.agilent.com/find/N6700)



**Agilent Technologies**